

---

**A Assembly Instructions  
Fortuna Birds Nest Tower  
Art. 4594-30-US**



**Operator:** \_\_\_\_\_

**Location:** \_\_\_\_\_

---

**Revision history**

Revision 0 – 2017-03-24

The first allowed version

Revision1 – 2018-11-07 Änderungen nach Angaben JF FH

Assembly Instructions

All rights reserved

© Copyright 2017 Huck Seiltechnik GmbH

---

## Contents

|          |   |           |
|----------|---|-----------|
| <b>A</b> | <b>Assembly Instructions Fortuna Birds Nest Tower Art. 4594-30-US</b> ..... | <b>1</b>  |
| 1        | Introduction Assembling .....   | 4         |
| 2        | Data sheet: Fortuna Birds Nest Tower, Art. 4594-30-US .....                 | 6         |
| 3        | Delivery contents (parts list with part numbers).....                       | 8         |
| 4        | Post installation checks.....   | 18        |
| <b>B</b> | <b>Maintenance Instructions Fortuna Birds Nest Tower Art.4594-30</b> .....  | <b>17</b> |
| 5        | Introduction Maintenance .....  | 19        |
| 6        | General maintenance information .....                                       | 20        |
| 7        | Maintenance timetableRegular maintenance.....                               | 23        |
| 8        | Monthly maintenance .....   | 23        |
| 9        | Quarterly maintenance.....  | 24        |
| 10       | Half yearly maintenance.....  | 24        |
| 11       | Annual maintenance.....   | 25        |
| 12       | Maintenance printout .....  | 26        |
| 13       | Hand over document .....  | 28        |

## List of Tables

|  |   |
|--|---|
| Table 3-1: Delivery contents, in words .....   | 8 |
| Table 3-2: Delivery contents, in symbols ..... | 9 |



The equipment must be installed by someone with the necessary expertise in strict compliance with the instructions from Huck Seiltechnik GmbH that are **delivered** with the equipment. **Use only the Installation instructions that are delivered with this equipment!**

A copy of the installation record should be given to the operator, who must confirm receipt.

---

---

# 1 Introduction Assembling

## 1.1 General information

This equipment should be installed, inspected, maintained and operated in accordance with ASTM F1487-17 guidelines.

**Before installation work commences, please check that you have all of the equipment and fixation components in the parts list provided (see Tables 3-1 and 3-2).**

**Please consider that the installation has to be carried out only on level terrain (max.slope up to 3%).**

Any spare parts that may be required can be obtained directly from your supplier.

Please do not hesitate to call your supplier if you have any problems during installation or in case of any other questions.



**Attention**

After installation the complete assembly instructions, maintenance instructions and a maintenance record must be sent to the operator who must confirm receipt in writing. See the last page of this document.



**Attention**

All nuts and bolts are hot-dip galvanised or stainless steel.

One of the characteristics of stainless steel is that uncontrolled cold welding may occur when the nuts are tightened. To prevent this, it is necessary to spray the nuts and bolts with Teflon spray or another similar lubricant.

---

**We hereby confirm that this play equipment has been tested and certified in accordance with the play equipment standard ASTM F1487-17.**

---

## **Drawings / Views**

All optical drawings are showing only the measurements/dimensions and are not standard technical views of the complete item. The Images (individual drawings) are not to scale!

We reserve the right to change technical details of our articles which are serving for the further development of our articles and are reasonable for the customer.

## **Measurement tolerances**

Because of the properties and characteristics of the components, minor measurement tolerances compared to the indication on the sketches are possible. This concerns all shown measurements except the foundation measurements below upper edge ground level/play area.

## 2 Data sheet: Fortuna Birds Nest Tower, Art. 4594-30-US

1. Safety zone: Ø 258.27"
2. Fall height 1000 mm (39.4 inches)
3. Minimum compressed loose-fill surfacing depths (refer to ASTM F1292 and ASTM F2223-10)

| Inches   | of (loose fill material) | Protects to | Fall height (feet) |
|--|--------------------------|-------------|--------------------|
| 2*   | Shredded/recycled rubber |             | 3.3                |
| 7,5  | Sand                     |             | 3.3                |
| 9  | Pea gravel               |             | 3.3                |
| 6.5  | Wood mulch(non-CCA)      |             | 3.3                |
| 4.5  | Wood chips               |             | 3.3                |
| *Shredded/recycled rubber loose-fill surfacing does not compress in the same manner as other loose-fill materials. However, care should be taken to maintain a constant depth as displacement may still occur. |                          |             |                    |

4. Name and overall dimension of the largest component:  
1x Steel post length 118.11", Ø 4.01"
5. Name and weight of the heaviest component:  
1x Steel post, approx. 55 pounds
6. Intended age group: 5 to 12 years
7. **Please note that this equipment is set in concrete.**  
Concrete: C25/30  
Required concrete: 28.5 ft<sup>3</sup>  
Foundations/area to be excavated: excavated (All foundations must be brought to equal level!)  
1 x 23.62" long x 23.62" wide, total depth 35.43" including 3.94" drainage  
2 x 26.77" long x 15.75" wide, total depth 31.5" including 3.94" drainage  
2 x 34.84" long x 15.75" wide, total depth 31.5" including 3.94" drainage



Attention!

**Round off foundation edges (min.R = 100 mm)! Types of foundation soil are "A&B" (natural ground).**

**Soil type A:** Cohesive, plastic soils with unconfined compressive strength greater than 1.5 ton per square foot (tsf)(144 kPa), and meeting several other requirements (with a lateral soil pressure of 25 psf per ft of depth.

**Soil type B:** Cohesive soils with unconfined compressive strength between 0.5 tsf (48 kPa) and 1.5 tsf (144 kPa), or unstable dry rock, or soils which would otherwise be Type A (with a lateral soil pressure of 45 psf per ft of depth.

**In case of sandy and soft soils, the total size of the foundations have to be enlarged by at least 50%!**

- 
8. Assembly time, once foundations completed: 3 hours.  
Required assistants: 2 persons.
  9. Any spare parts which may be required can be obtained directly from your supplier.
  10. We hereby confirm that this item of play equipment has been tested and certified in accordance with the play equipment standard ASTM F1487-17.

---

### 3 Delivery contents (parts list with part numbers)

#### 3.1 In words





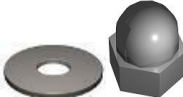

Table 3-1: Delivery contents, in words



| Pos.   | Quantity | Element / Description                            | Size             | O.K. | Missing |
|--|----------|--|------------------|------|---------|
| 1  | 1        | Steel post                                       | Ø4.01" x 118.11" |      |         |
| 2  | 1        | Net component                                    |                  |      |         |
| 2a   | 2        | Post clamp                                       | Ø 4.01"          |      |         |
| 3  | 1        | Post cap   | Ø 4.01"          |      |         |
| 4  | 2        | Carriage bolt                                    | M10 x 40 mm      |      |         |
| 5  | 2        | Nyloc Acorn nut and washer                       | M10              |      |         |
| 6  | 8        | Screw in ground anchors                          |                  |      |         |
| 7  | 3        | Self tapping screws                              | 6.3 x 25 mm      |      |         |
| 8  | 1        | Loctite  |                  |      |         |
| 9<br> | 1        | Middle Foundation Pipe<br>(provided by Customer) | Ca. Ø 6" X 21.5" |      |         |



### 3.2 In symbols

Table 3-2: Delivery contents, in symbols

| Pos. | Quantity | Symbol  |
|------|----------|---|
| 1    | 1        |  <p data-bbox="730 566 1161 607">Ø 4.01" x 0.11" x 118.11" long</p> |
| 2    | 1        |    |
| 2a   | 2        |   |
| 3    | 1        |    |
| 4    | 2        |   |
| 5    | 2        |   |
| 6    | 8        |   |

| Pos. | Quantity | Symbol  |
|------|----------|---|
| 7    | 3        |   |
| 8    | 1        |   |
| 9    | 1        |  <p data-bbox="786 633 1121 723">Middle Foundation Pipe<br/><b>(provided by Customer)</b><br/>ca. Ø 6" X 21.5" long</p> |

## 4 Foundation side and top view

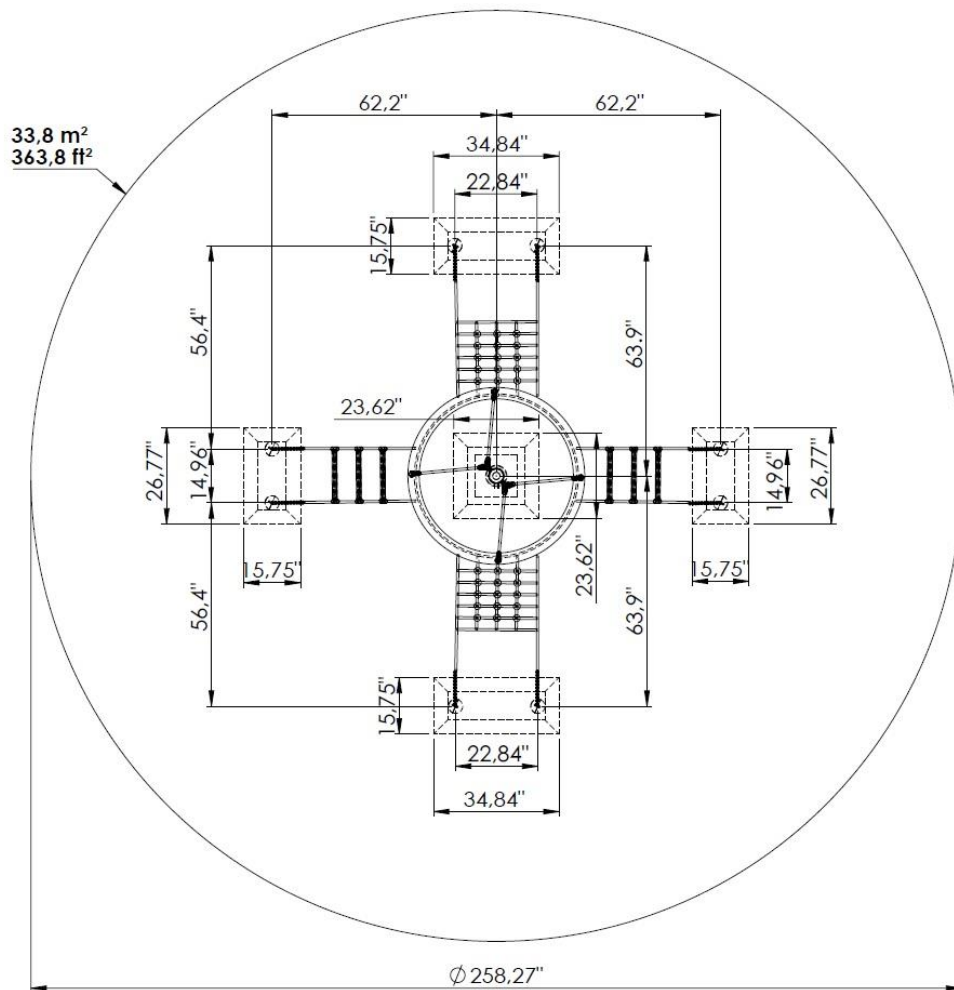
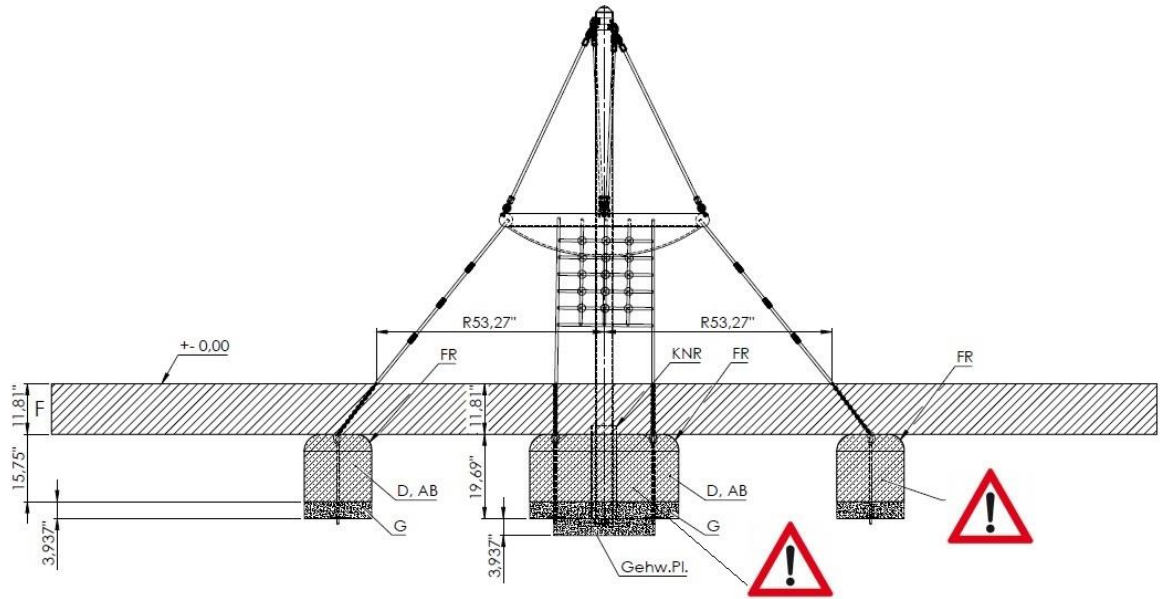

---

## Loctite-Thread locking adhesive!

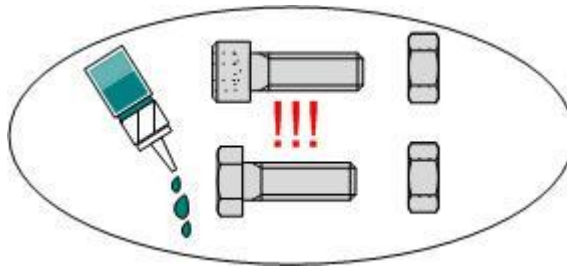

Glue all screws, nuts and sleeves with loctite.  
(Not less than 5 drops!)  
(Except for Nyloc nuts)

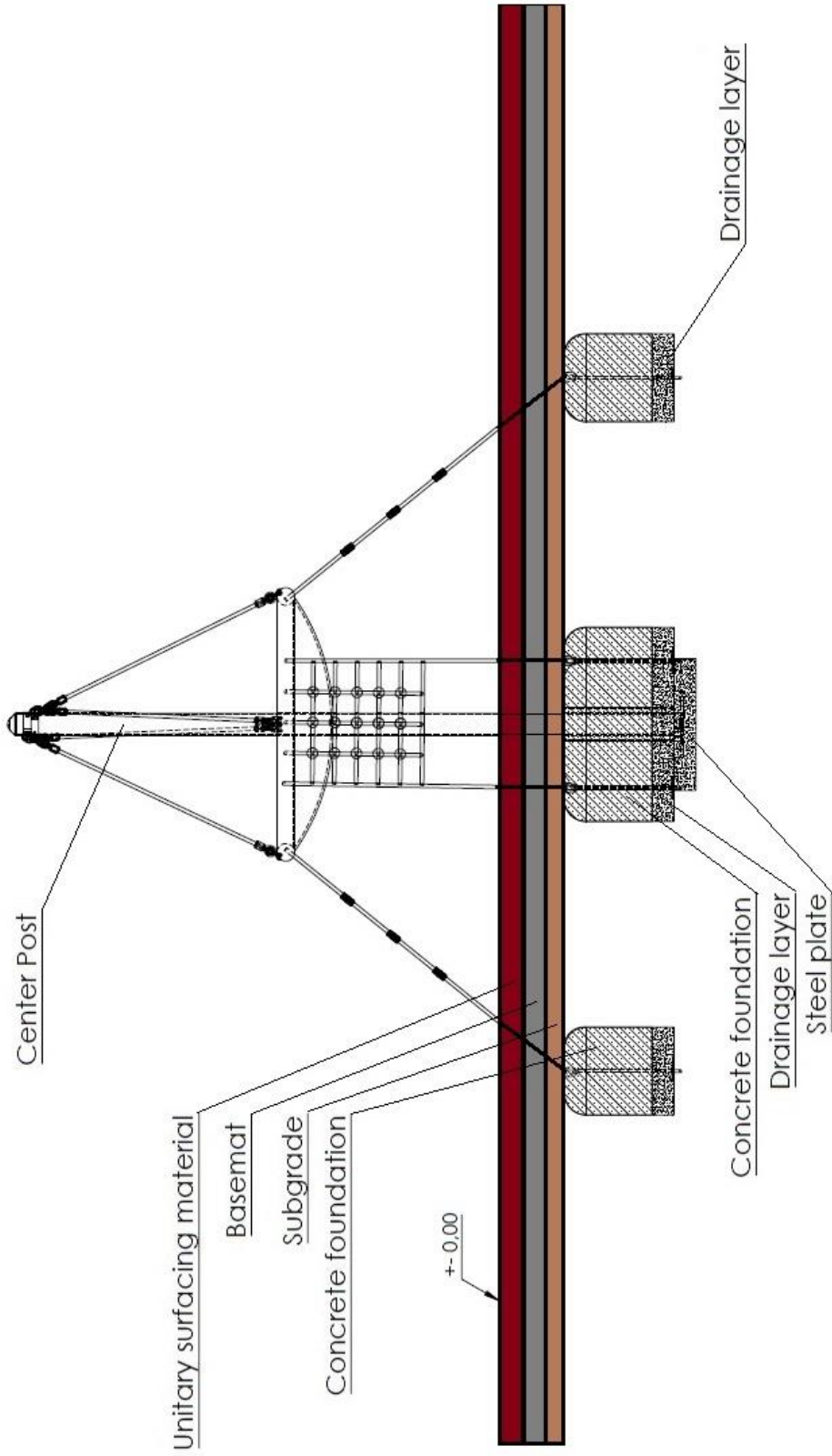

**Please refer to ASTM F1292 / ASTM F1951 / ADA / ABA standards when choosing the thickness of Unitary surfacing material. IPEMA certified surfacing manufacture-Installers are highly recommended.**

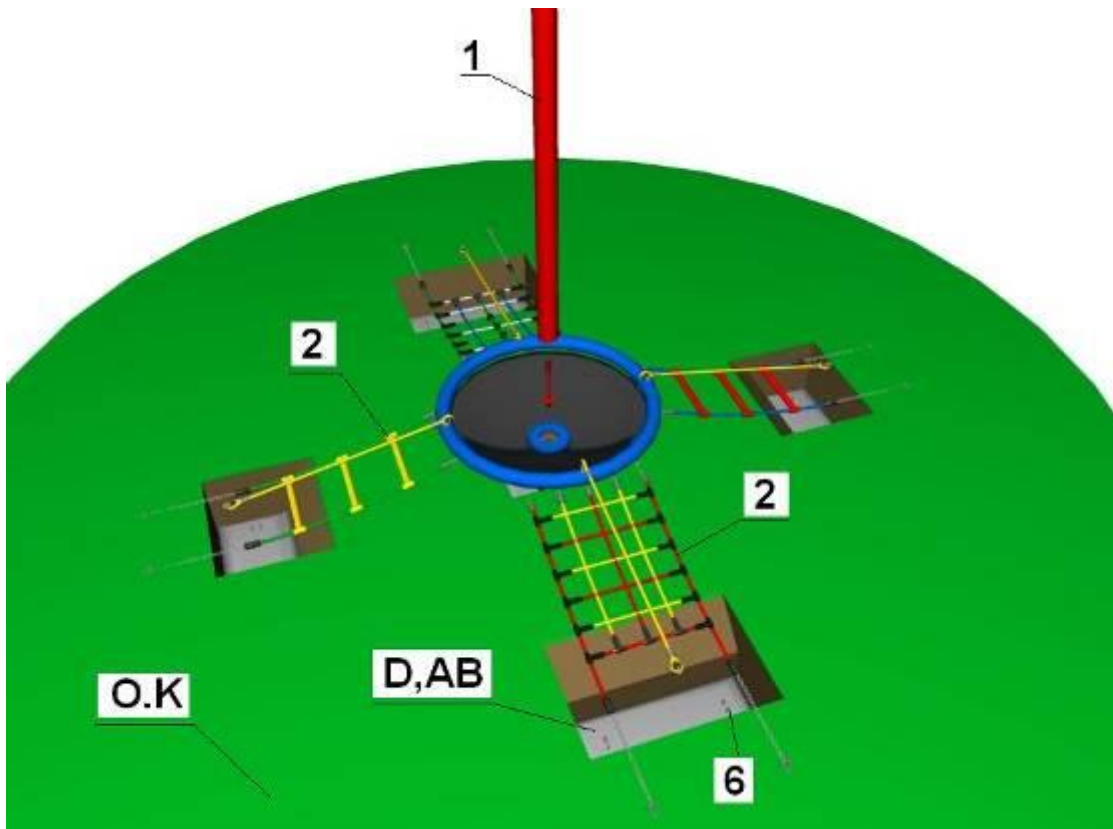
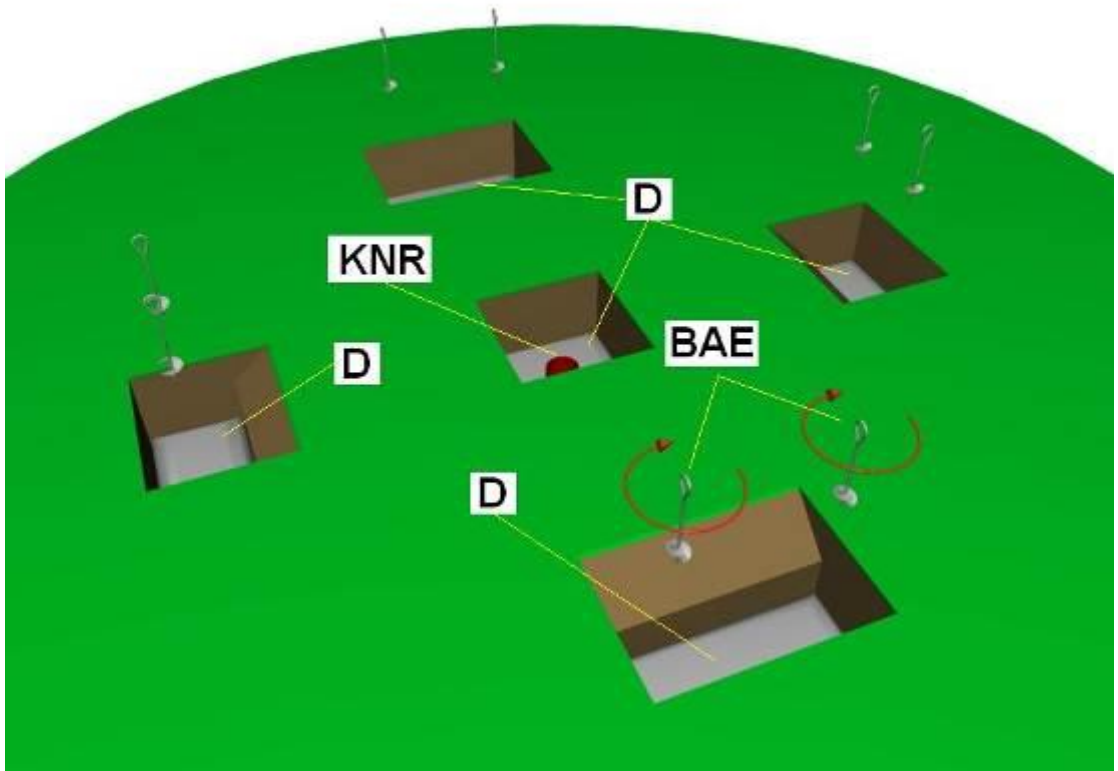

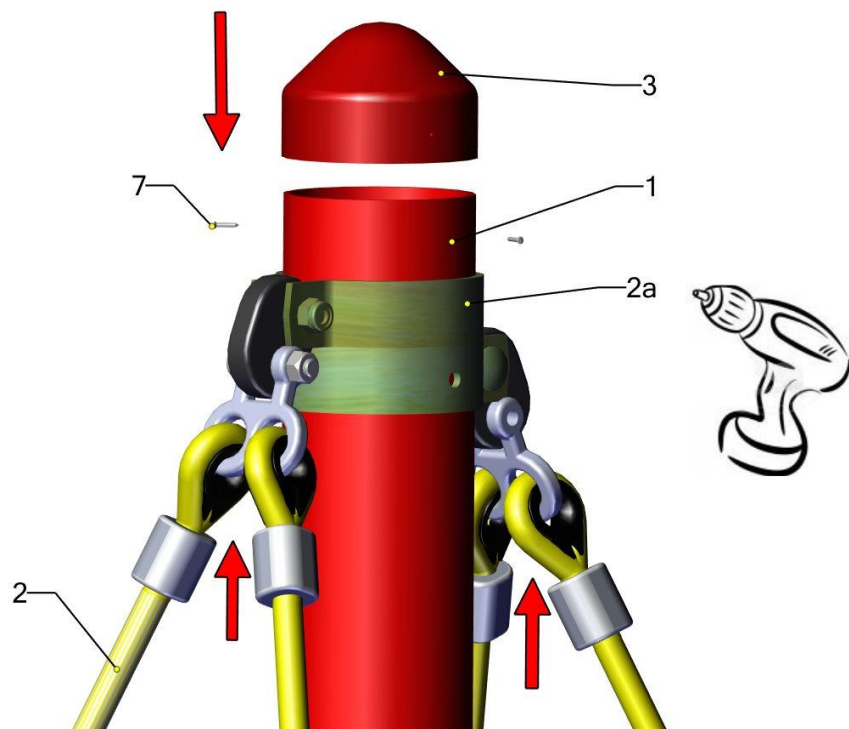
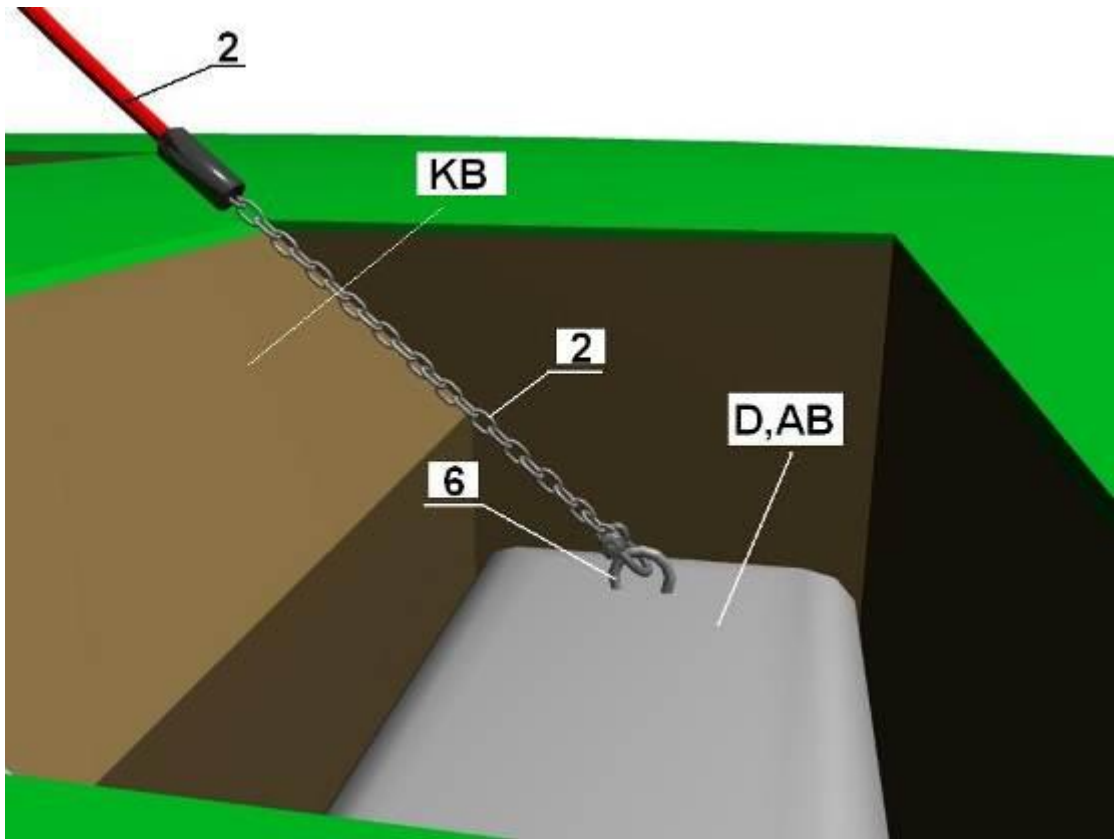

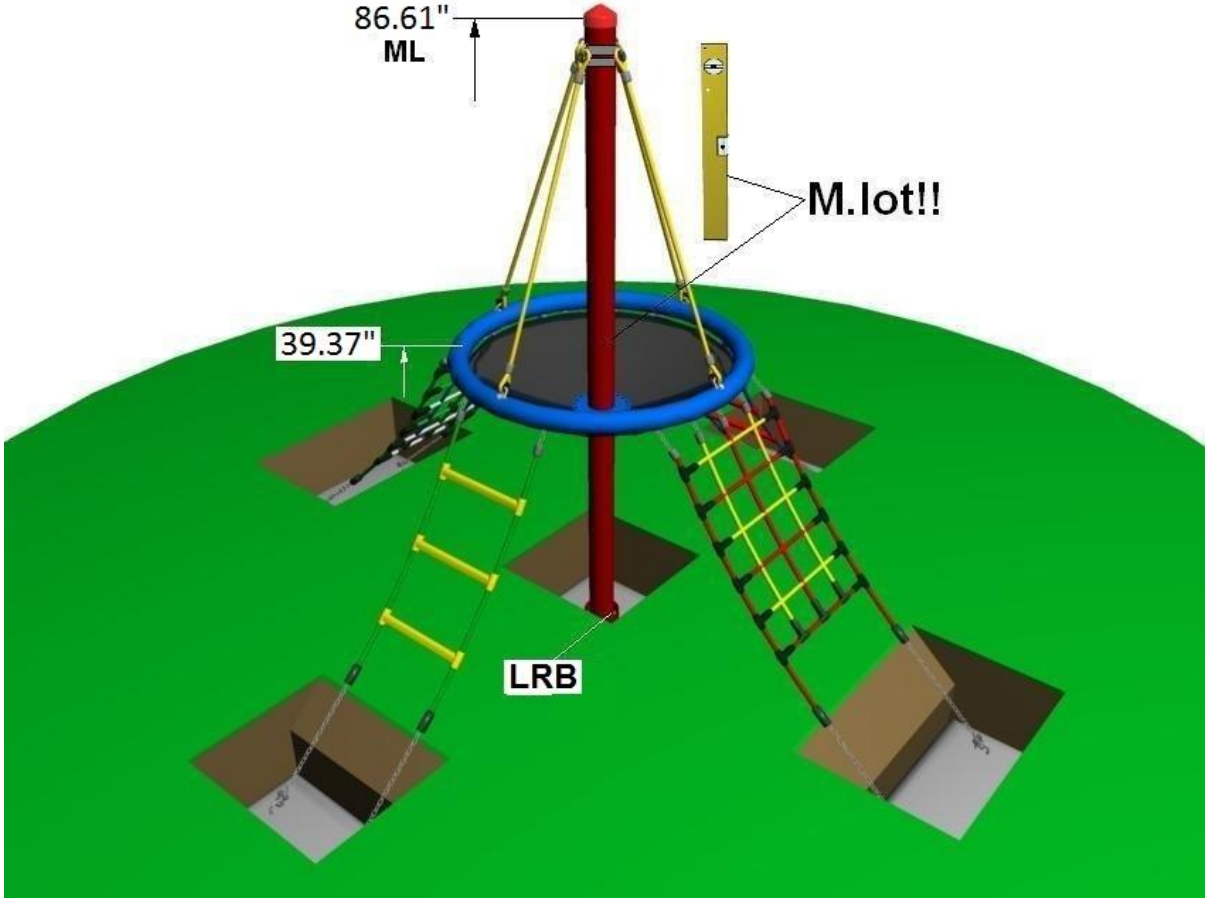



---

|                 | <b>Abbreviations for Fortuna Birds Nest Tower</b> |
|-----------------|---|
| <b>AB</b>       | Dry time for concrete                             |
| <b>D</b>        | Concrete C25/30 (for foundations)                 |
| <b>BAE</b>      | Intall Pos.6                                      |
| <b>G</b>        | Drainage layer                                    |
| <b>F</b>        | Fall protection                                   |
| <b>KNR</b>      | Middle foundation pipe                            |
| <b>LRB</b>      | Fill with Concrete after installation is complete |
| <b>ML</b>       | Mast length above playing level                   |
| <b>M.Lot !!</b> | Install post vertically level                     |
| <b>Gehw.PI.</b> | Sidewalk stone                                    |
| <b>P</b>        | Post  |
| <b>O.K</b>      | Upper edge of playing level                       |
| <b>S</b>        | View  |
| <b>PS</b>       | Safety area                                       |
| <b>VO</b>       | Pre-fitted  |

**See drawings for details of shortcuts**

---

## 5 Post installation checks

---



If the equipment has not been installed correctly, you must ensure that the public is prevented from using it.

---

### 5.1 Marking filler depth

- Labelling the posts to show the depth of material provided as fall protection (i.e. loose filler).

### 5.2 The equipment has not been installed safely in the following cases:

- Installation of equipment is not complete.
- The protective surface has not been installed yet.
- Appropriate maintenance work cannot guarantee operational safety.

### 5.3 Removal of all assembly aids

- Please make sure that all assembly aids have been removed from the playing area. The equipment must not be approved for use until this check has been carried out.

### 5.4 Information about inspection of the equipment before it is used for the first time

- There are no special inspection requirements to be met before the equipment is used for the first time.

### 5.5 Retighten bolts

- After one week of play, please retighten all bolts again. Later upon respective maintenance.

---

**B Maintenance Instructions**  
**Fortuna Birds Nest Tower**  
**Art.4594-30**

---



---

**Revision history**

Revision 0 – 2017-03-24

The first allowed version

Revision1 – 2018-11-07 Änderungen nach Angaben JF FH

Assembly Instructions

All rights reserved

© Copyright 2017 Huck Seiltechnik GmbH

---

## 6 Introduction Maintenance

### 6.1 General informations

This equipment should be installed, inspected, maintained and operated in accordance with ASTM F1487-17 guidelines.



**Please note:** Providing any necessary repairs are carried out, a piece of play equipment that is inspected regularly cannot become so damaged that it is dangerous to the user.

---

Any spare parts which may be required can be obtained directly from your supplier.



This equipment should only be assembled, maintained and repaired by **persons with the necessary expertise.**  
**A copy of the inspection record should be given to the operator, who must confirm receipt.**

---

**These maintenance instructions are based on the standard  
ASTM F1487-17**

---

## **7 General maintenance information**

### **7.1 Maintenance intervals**

Maintenance intervals are based on average use. Please note that more frequent inspections and/or maintenance are required if the play equipment is subject to intensive use.

### **7.2 Inspection frequency**

The frequency of inspections must be based on actual use. Factors that affect frequency include vandalism, location (e.g. coastal proximity), air pollution and the age of the equipment.

### **7.3 Maintenance products and procedures**

All nuts and bolts are hot-dip galvanised or stainless steel. One of the characteristics of stainless steel is that uncontrolled cold welding/Thread grinding may occur when the nuts are tightened. To prevent this, it is necessary to spray the nuts and bolts with Teflon spray or another similar lubricant.

### **7.4 Spare parts**

All spare parts must conform to the manufacturer's specifications.

### **7.5 Identifying spare parts**

All spare parts are listed in the parts list. The parts list follows the installation requirements.

### **7.6 Special instructions for the disposal of individual equipment components**

No special instructions are necessary.

### **7.7 Actions to be taken during the break-in period**

No later than 2 weeks after assembly, all screwed connections should be checked and tightened if necessary. Ropes connected to foundations **must** be retensioned

### **7.8 Maintenance of protective surfaces**

Surfaces providing fall protection must also be maintained regularly. It is particularly important to maintain the correct level of loose surface material and add more if necessary (refer to ASTM F1292 and ASTM F2223).

---

## 7.9 Defects

---



**Attention**

Damages must be repaired as soon as they are detected. If serious defects that affect the safeness cannot be repaired straight away, the equipment then must be closed with immediate effect to prevent further use.

---

## 7.10 Loose screws

---



**Attention**

Loose screws always cause quality problems and put safety at risk. Therefore, loose screws should always be tightened and checks carried out to ensure that there are no missing screws.

---

## 7.11 Preventing equipment use

Use of the equipment should be prevented in the event of incomplete installation, disassembly, maintenance, repairs and defects.

## 7.12 Claims/liability for defects (steel posts)

Steel posts and footings are covered by our guarantee if regular maintenance is carried out and recorded in writing.

Our general terms and conditions apply. Maintenance of steel posts first take place after 3 years. The steel posts must be excavated down to the concrete foundations and checked for corrosion. Zinc paint should be applied to any corroded areas and scratches. Check ropes for abrasion, replace ropes where coating is worn down the steel core.

---

## 8 Maintenance timetable

### 8.1.1 Maintenance interval

We strongly advise you to carry out inspections and maintenance work within the specified periods as use of the equipment, the weather and malicious vandalism cause wear and tear that compromises the safety and function of the equipment.

### 8.1.2 Maintenance intervals in the event of intensive use

Please note that more frequent inspections and/or maintenance are required if the play equipment is subject to intensive use.

### 8.1.3 Defects that compromise safety



In the event of defect that compromises safety, quick action must be taken. This may involve repairing it immediately or shutting down and dismantling the equipment.

### 8.1.4 Defects that compromise function



Defects that compromise function should also be repaired immediately. Such defects lower the value of the equipment to the user and encourage malicious vandalism, which may render the equipment less safe. Any damage should also be repaired immediately.

---



---

## 9 Regular maintenance

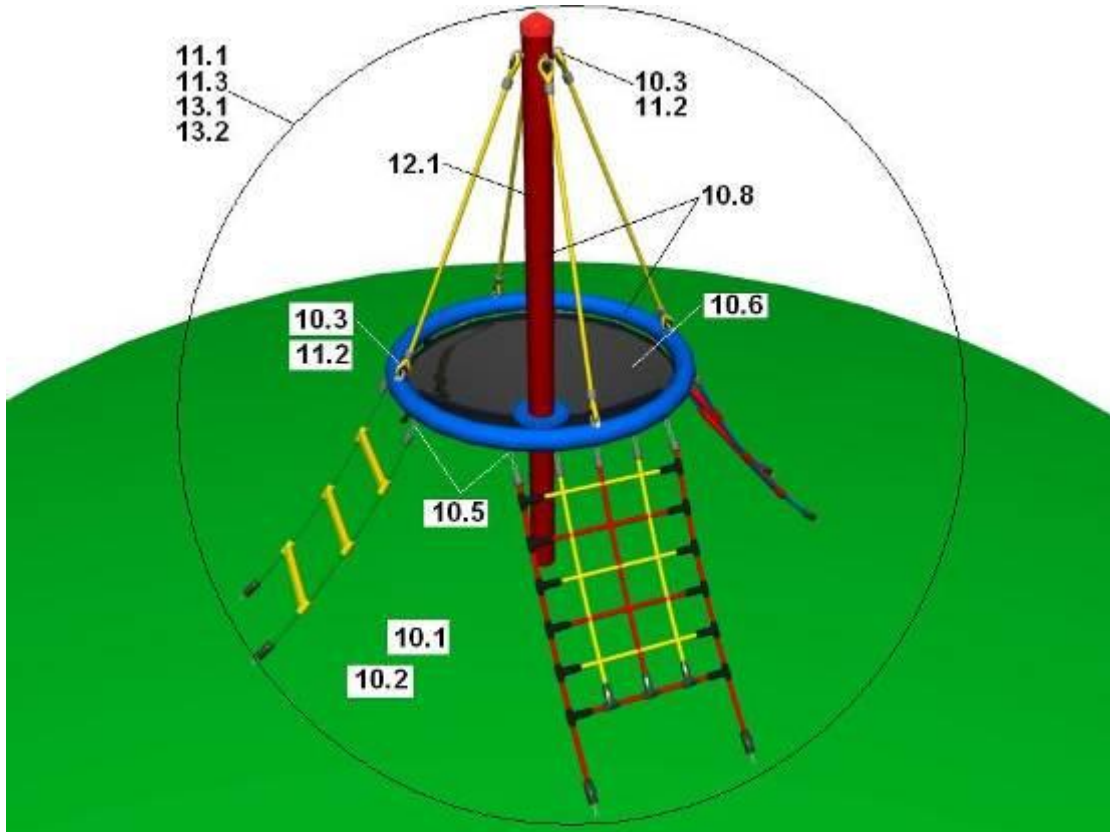

## 10 Monthly maintenance

- 10.1 Check the spaces between the equipment and the ground (clearance and height of fall).
- 10.2 Check the ground surface of fall protection for hard objects and loose foundations.
- 10.3 Check all connecting elements and fittings for wear and tear and tighten if necessary. Repair or replace damaged or missing parts.
- 10.4 Check that moving metal parts (joints, springs, etc.) move smoothly and are not worn. Repair or replace if necessary. It is not necessary to lubricate joints as we only use maintenance-free metal roller bearings.
- 10.5 Check all attachments such as chains, ropes, nets, etc. for damage and tension, repair or replace if necessary.
- 10.6 Check rubber parts, sleeves, etc. for wear and tear or damage and repair or replace if necessary.

- 
- 10.7** If necessary, remove excess padding material from the post footings due to danger of rotting.
  - 10.8** Check the surface of wooden parts for damage caused by the weather or external influences and mold. Repair or replace if necessary.
  - 10.9** Check the surface of plastic and metal parts, e.g. slides, for damage and replace if necessary.
  - 11** **Quarterly maintenance**
    - 11.1** Detailed inspection of the operation and stability of the equipment paying particular attention to any wear and tear.
    - 11.2** Tighten all forms of attachment.
    - 11.3** Repaint and retreat surfaces if necessary.
    - 11.4** Maintenance of fall protection surfaces.
    - 11.5** Lubrication of joints.
    - 11.6** Check height of fall protection material and fill up with filler if necessary. If the posts are labelled, fill up to the mark.
    - 11.7** Retension the tension ropes after a period of 3 months. Afterwards please check in equal intervals.
    - 11.8** Retighten all bolts.
  - 12** **Half yearly maintenance**
    - 12.1** The stability of supporting posts, supports, foundations etc. has to be checked. The safety level of the entire system has to be checked after repairs have been carried out or additional system components have been installed or replaced.



## **Annual Maintenance**

---

### **13 Annual maintenance**

- 13.1 Ascertaining that the equipment, foundations and surfaces are safe for operation.**
  - 13.2 In particular, the equipment should be checked for decay and corrosion. It may be necessary to dig out or excavate certain components in order to do so. Zinc paint should be applied to corroded areas and scratches.**
- 
-

**14 Maintenance printout**

Name of item: Fortuna Birds Nest Tower \_\_\_\_\_ / Art. No. 4594-30 \_\_\_\_\_

Location: \_\_\_\_\_

Customer or operator: \_\_\_\_\_  
 (Town, Town council, Kindergarten)

| Date of inspection | Inspector | O.K. | Accessible | Barriered | Defects | Repaired by | Date |
|--------------------|-----------|------|------------|-----------|---------|-------------|------|
|                    |           |      |            |           |         |             |      |
|                    |           |      |            |           |         |             |      |
|                    |           |      |            |           |         |             |      |
|                    |           |      |            |           |         |             |      |
|                    |           |      |            |           |         |             |      |
|                    |           |      |            |           |         |             |      |
|                    |           |      |            |           |         |             |      |
|                    |           |      |            |           |         |             |      |
|                    |           |      |            |           |         |             |      |
|                    |           |      |            |           |         |             |      |

**Please copy and return once a year after main inspection has been carried out to the owner/ operator**

**by Telefax**

**Place the confirmation form in the play equipment files.**



## 15 Hand over document

---



After the installation of the equipment, pass the installation and maintenance documents to the operator. The operator has to receive the hand over documents. The complete filled out and signed Hand over document should be copied and sent to the supplier.

---

Art.-No.: 4595-30

Type of item: Fortuna Birds Nest Tower

Serial number: \_\_\_\_\_

**Customer or operator (Town, Town council, Kindergarten, etc.):**

\_\_\_\_\_  
\_\_\_\_\_

Competent person in charge:

\_\_\_\_\_  
\_\_\_\_\_

**Installation company (address):**

\_\_\_\_\_  
\_\_\_\_\_

Responsible assistant (assembler):

\_\_\_\_\_  
\_\_\_\_\_

Received the complete assembly instructions, maintenance instructions and maintenance printout.

\_\_\_\_\_

(Signature of operator)      (Signature of Installation Company)  
(Stamp)

Date: \_\_\_\_\_