

78-21008

PART LIST

FRONT

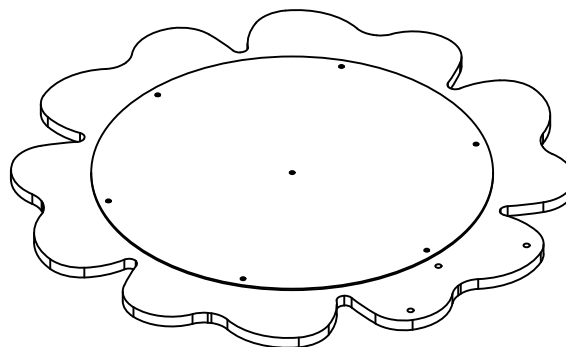
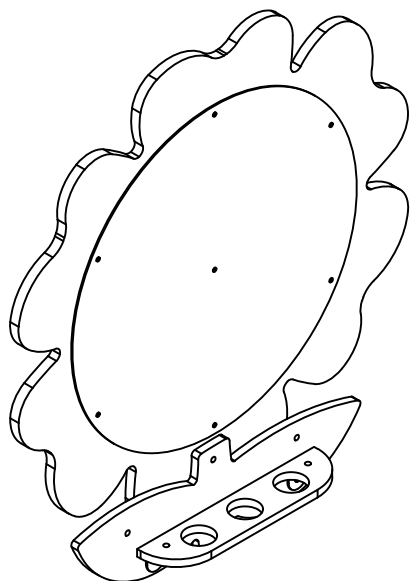

X1

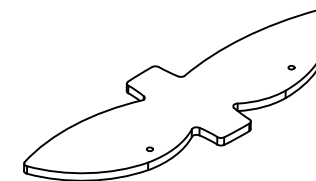

X1

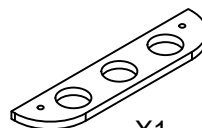

X1

HARDWARE

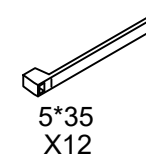
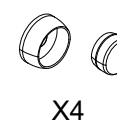
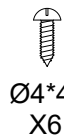

WARNING:

- Contains small parts, sharp points and edges.
- Adult assembly required.
- Two adults recommended.
- Do not stand, sit, kneel, lean or pull on unit for support.
- Never leave children unattended.
- Do not place unit near high heat or moisture.
- Adult supervision recommended.

TIP!
DO NOT FULLY
TIGHTEN SCREWS
UNTIL ALL SCREWS
HAVE BEEN LOOSELY
POSITIONED.

BEFORE
ASSEMBLING,
MAKE SURE THERE
ARE NO
MISSING PARTS.

NOTE:
A ELECTRIC
SCREWDRIVER WILL
BE RECOMMENDED FOR
ASSEMBLY(NOT INCLUDED)

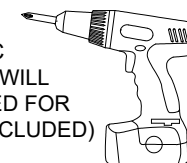

1

Ø8*30
X4



Ø6*25
X3



M8
X4

Ø6*12
X3

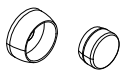

M8
X4

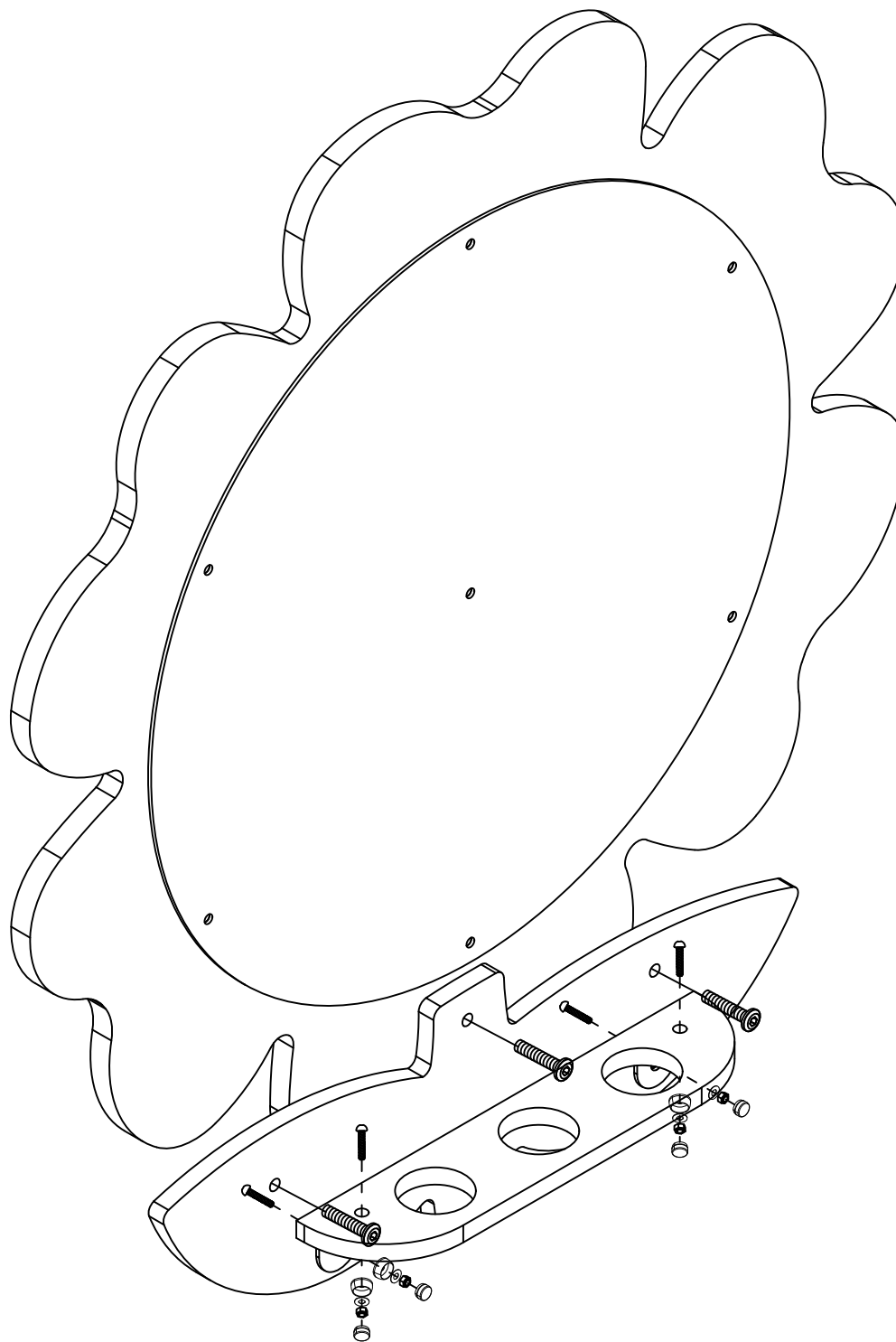
X2

X4

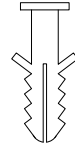
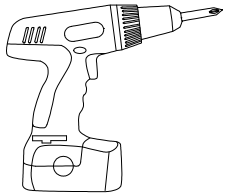

2



X6

3

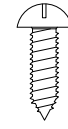

4*45

Drill a hole in the wall and hammer an expansion screw into the hole.

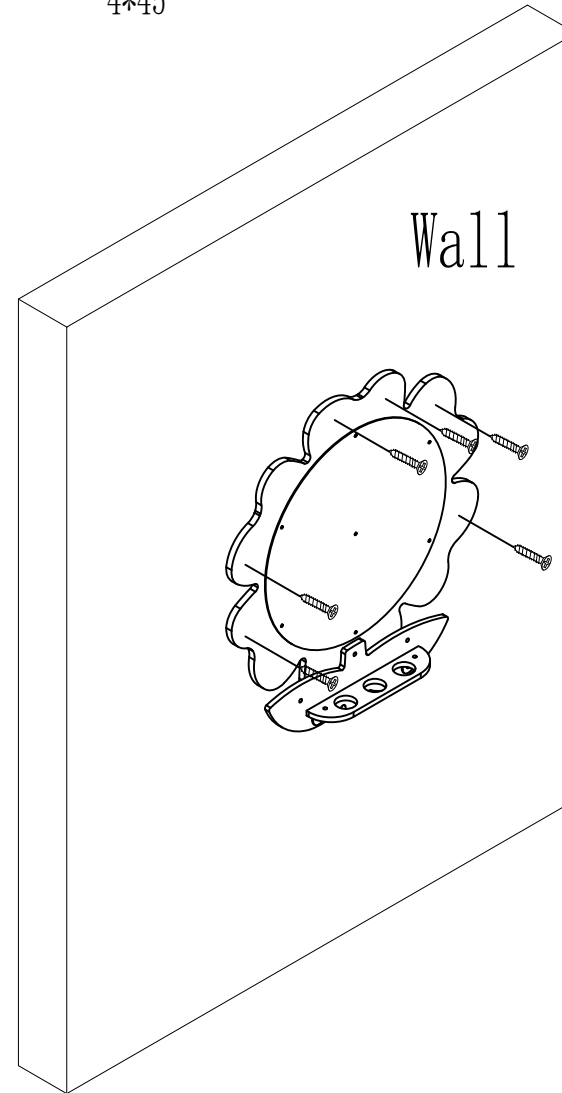
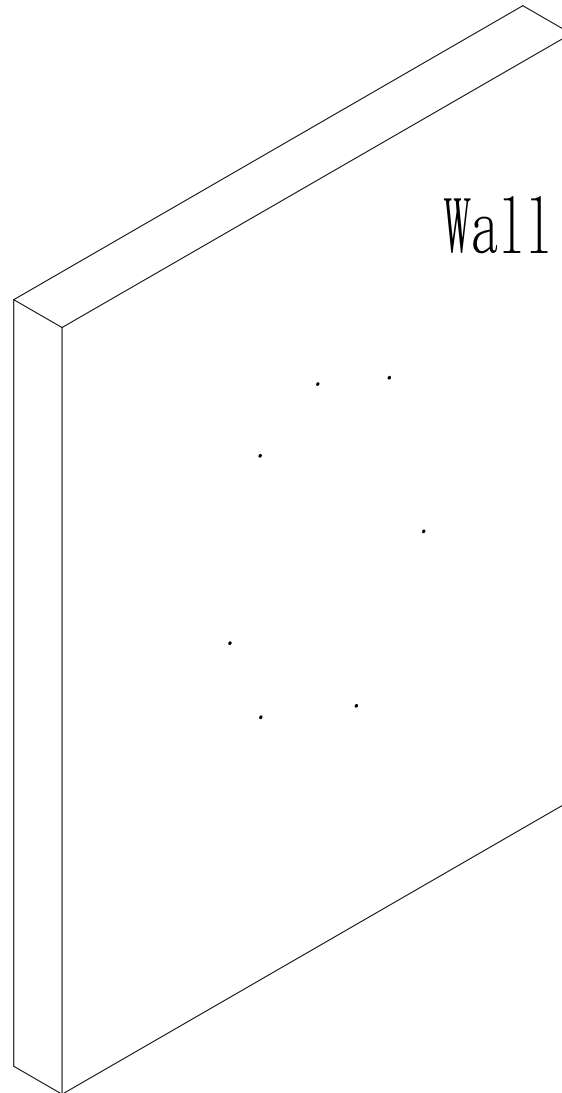

4

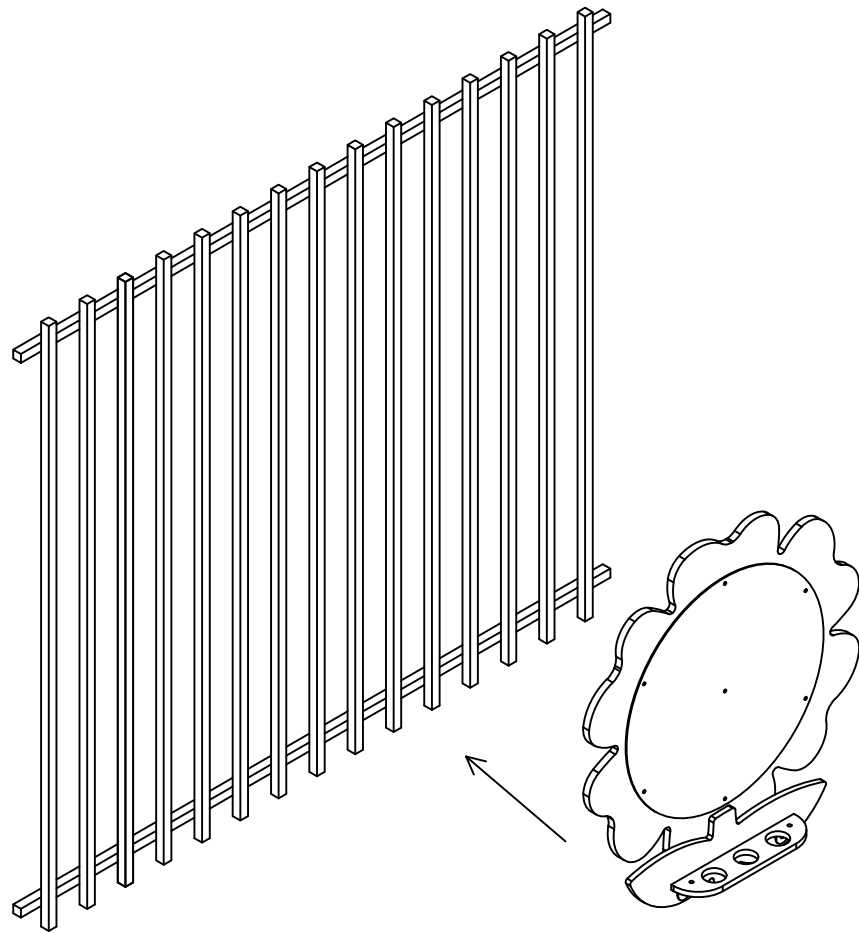

5

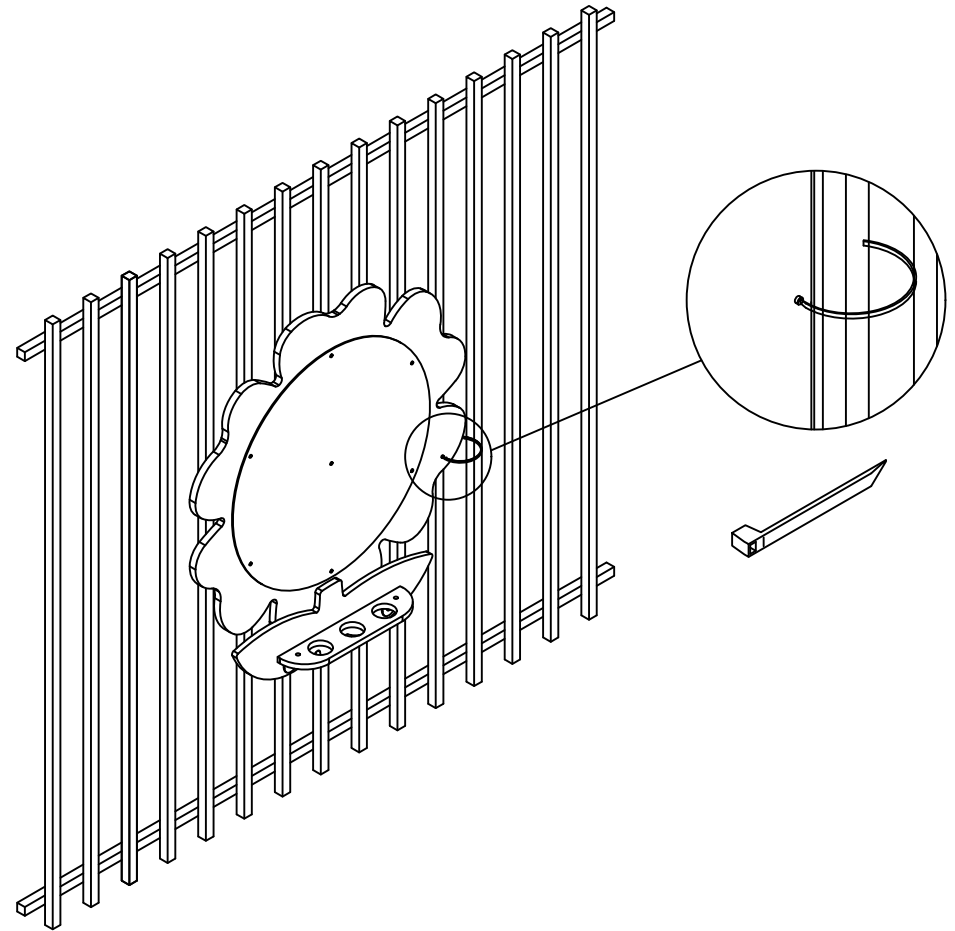

Note: This product needs to be fixed to the iron fence, please use plastic ties to install it when fixing.



CAUTION:

- Do not allow children to climb on shelves.
- Do not use as a ladder or cart.

CARE AND CLEANING

- Clean wood with a damp cloth or sponge using warm water and mild soap. Wipe dry.
- Do not place near heat, moisture or vaporizer which may cause wood to warp and peel.
- Check for loose or worn parts periodically and tighten or replace as necessary.

1 YEAR LIMITED WARRANTY

Our products will supply to the original owner, without charge, any part discovered to be missing at the time of purchase or found to be defective during the 1-year warranty period. The warranty begins on the date of purchase. The model number and the part description must be owner damage, product alteration, or unreasonable use. If you need assistance, contact Us.

Record the manufacture date here. Information is located on a label enclosed, and on the shipping carton. Place label and this sheet in an accessible place.

Model Number: **78-21008**

Manufacture Date: _____

Fasten your Hex Key Tool in the box below and keep in a convenient place for future use.

