

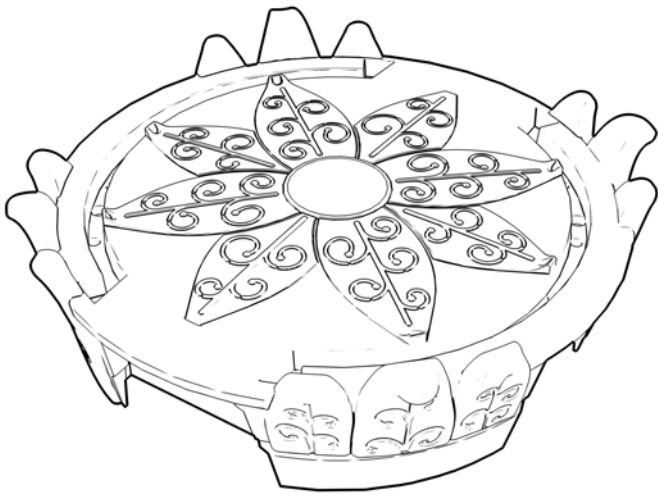

# Happy Hollow

## Inventory List and Install Guide



**HH01**  
Quantity: 1

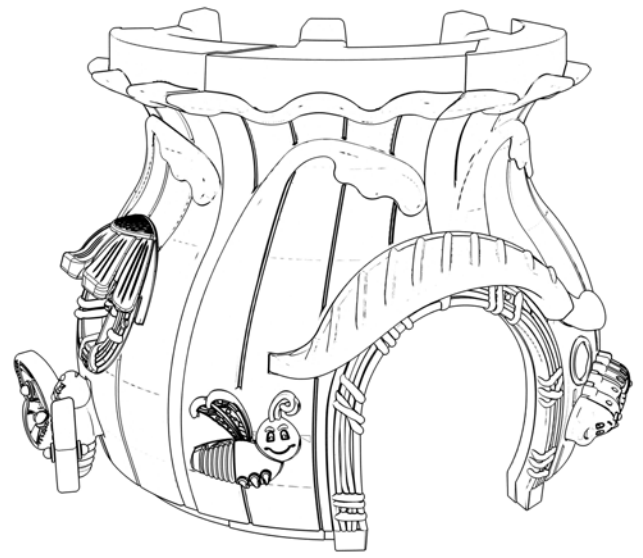

**HH02**  
Quantity: 1

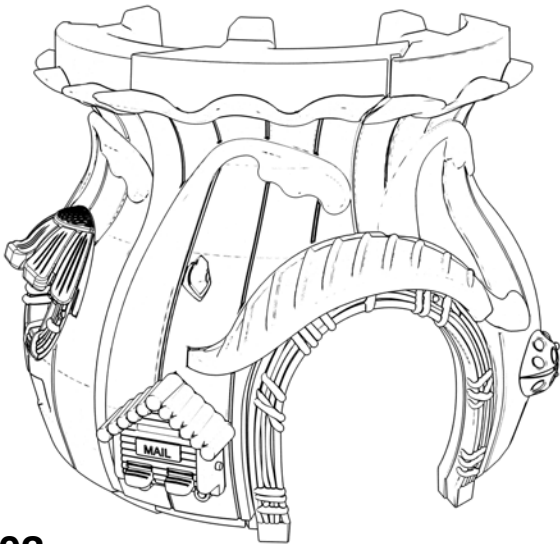

**HH03**  
Quantity: 1

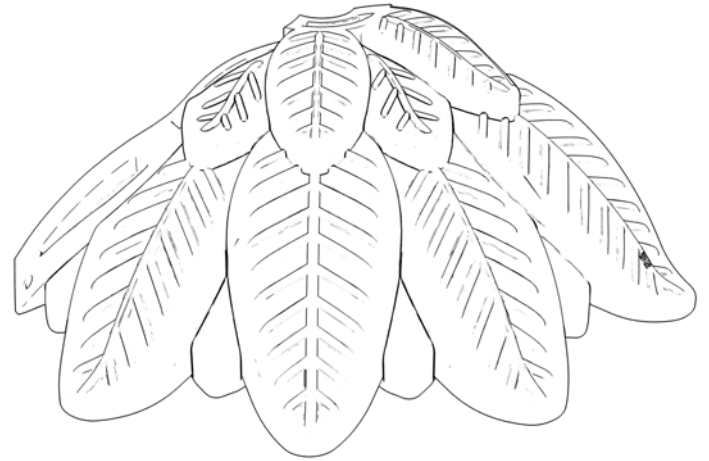

**HH04**  
Quantity: 3

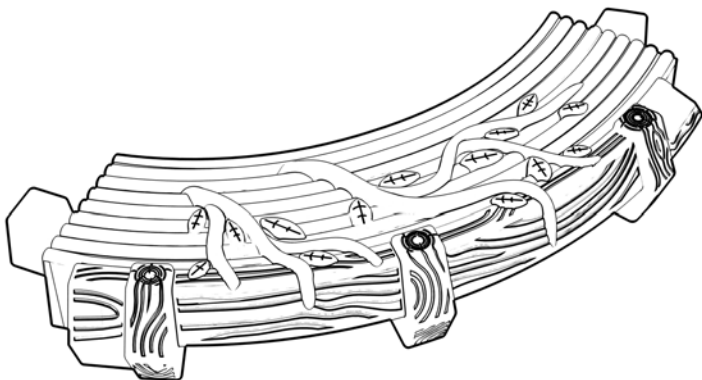

**HH05**  
Quantity: 1



**HH06**  
Quantity: 1

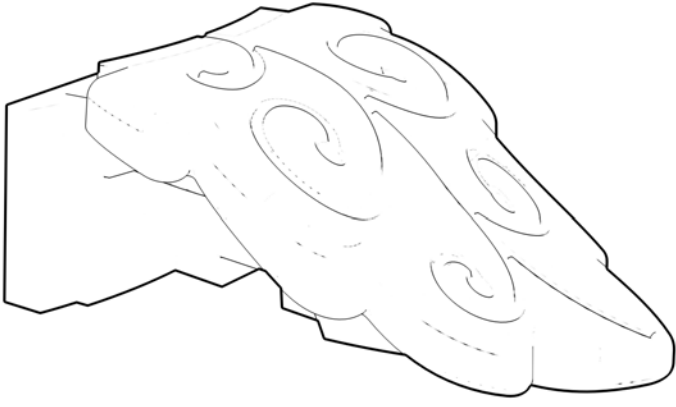

**HH07**  
Quantity: 1

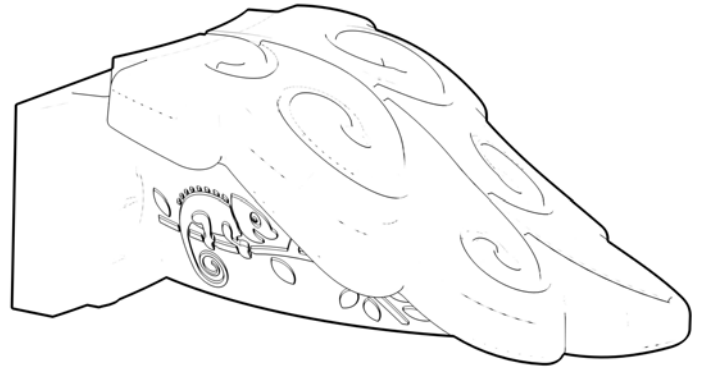

**HH08**  
Quantity: 1

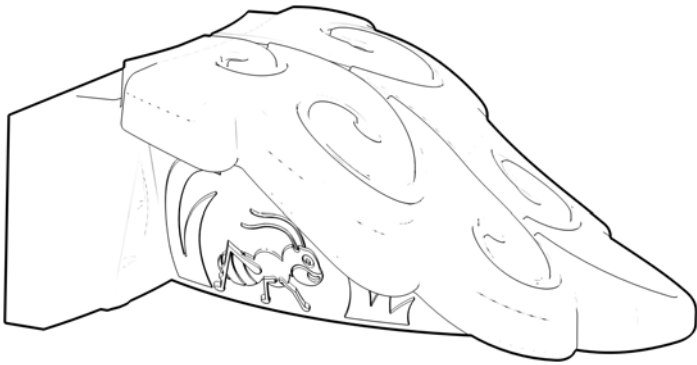

**HH09**  
Quantity: 1

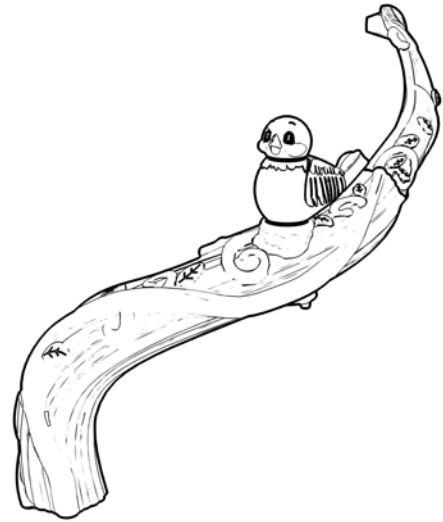

**HH10**  
Quantity: 1

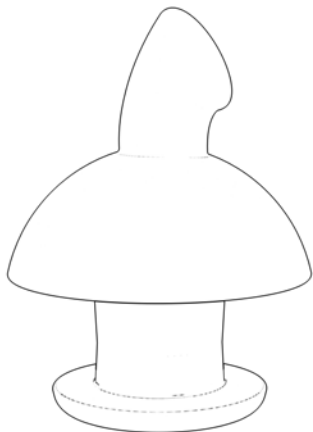

**HH11**  
Quantity: 1

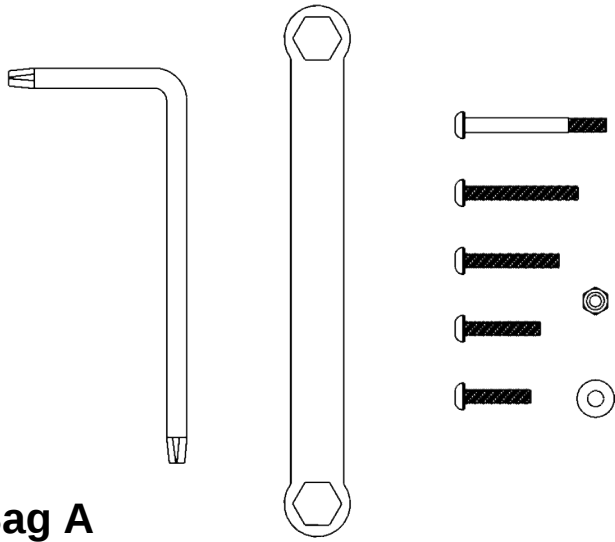

**Bag A**  
Tools and Extra Hardware

\* We recommend that you DO NOT use power tools during the assembly of the Happy Hollow

Shown to-scale

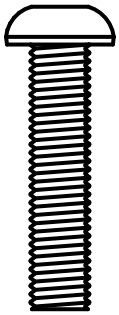

**Bag B**  
Size: M8\*35mm  
Quantity: 17

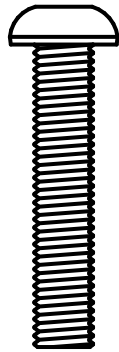

**Bag C**  
Size: M8\*40mm  
Quantity: 13

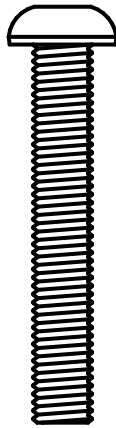

**Bag D**  
Size: M8\*50mm  
Quantity: 7

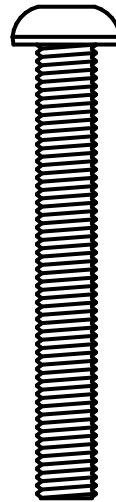

**Bag E**  
Size: M8\*60mm  
Quantity: 2

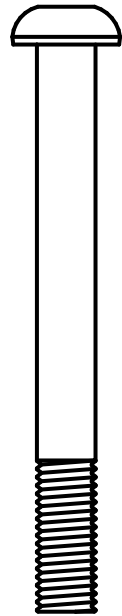

**Bag F**  
Size: M8\*75mm  
Quantity: 3

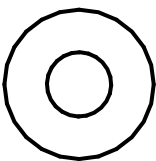

**Bag G**  
Size: M8  
Quantity: 44



**Bag H**  
Size: M8  
Quantity: 2

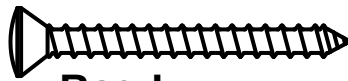

**Bag I**  
Self Tapping Screw  
Quantity: 2

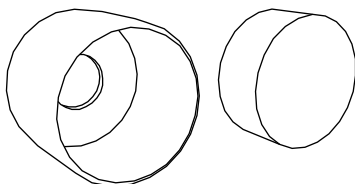

**Bag J**  
Color: Light Blue  
Quantity: 10

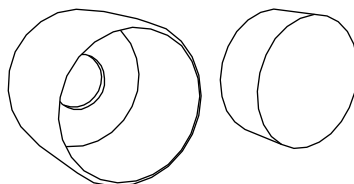

**Bag K**  
Color: Light Green  
Quantity: 12

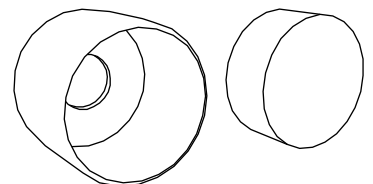

**Bag L**  
Color: Dark Green  
Quantity: 8

# Optional Mounting Packages

Sold Separately

## In-Ground Mounting Package

### In-Ground Mounting Stakes

Qty: 4

### Recommended Tools:

Hammer

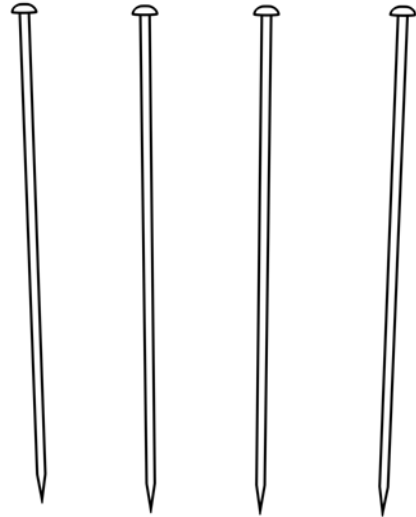

---

## Surface Mounting Package

### Surface Mounting Plates

Qty: 4

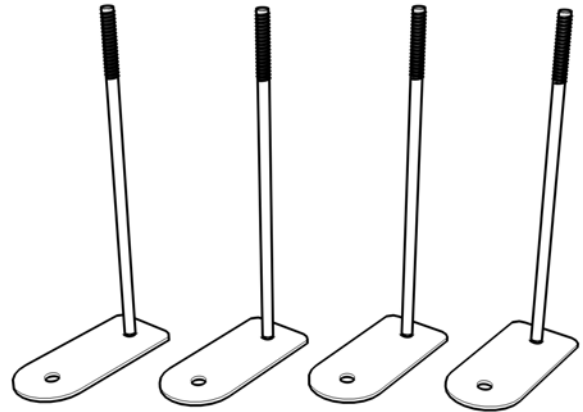

### M10 Washer

Qty: 4



### M10 Locking Nut

Qty: 4



### Recommended Tools:

Socket Wrench

17mm Deep Well Socket

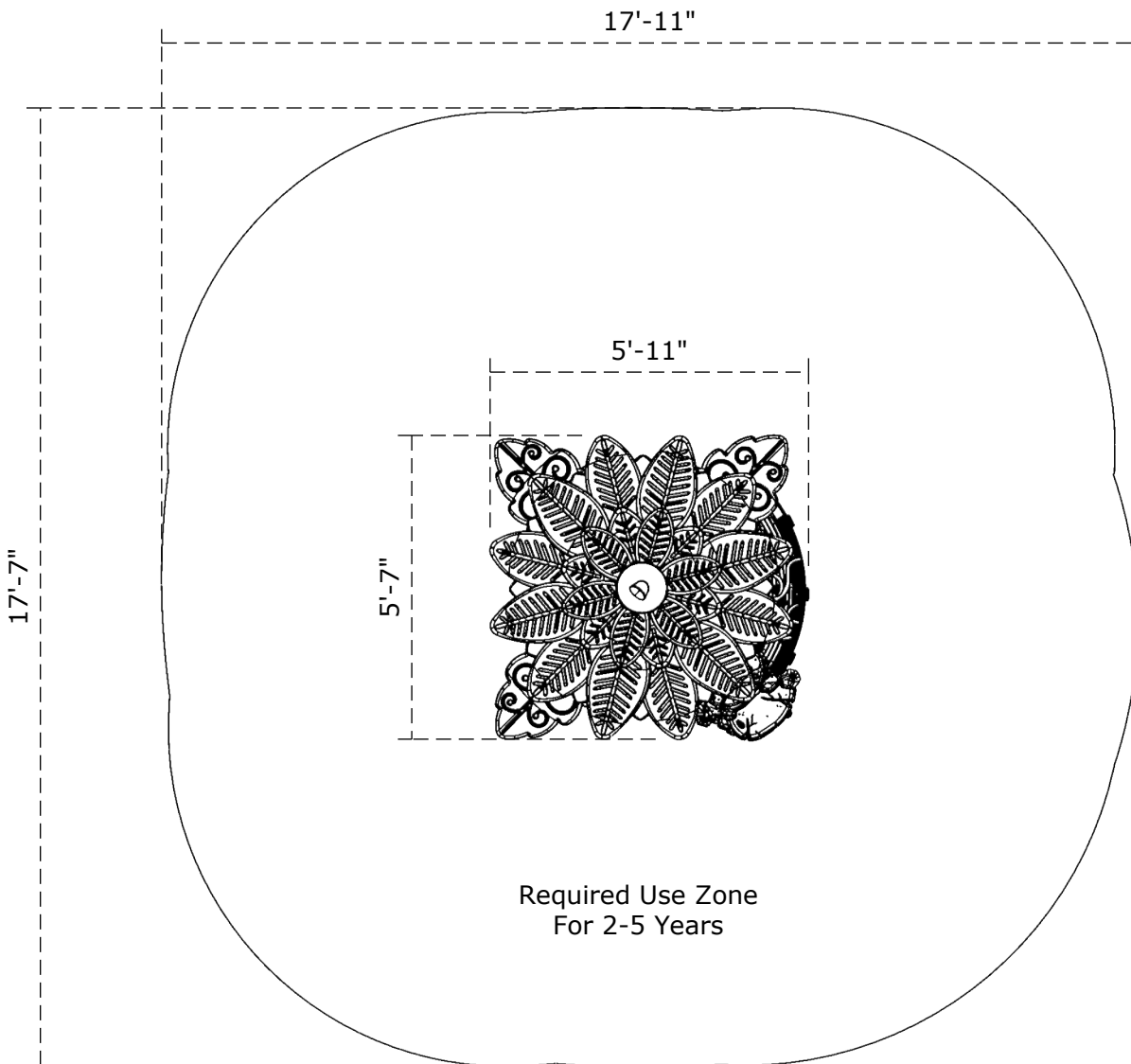
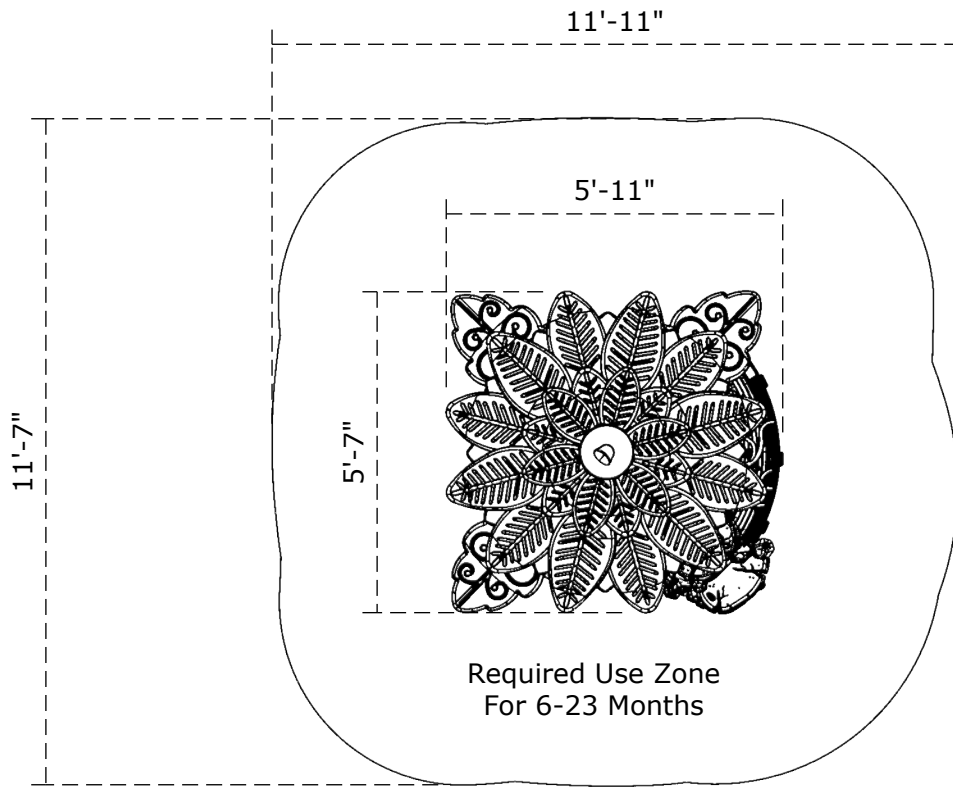

# 1

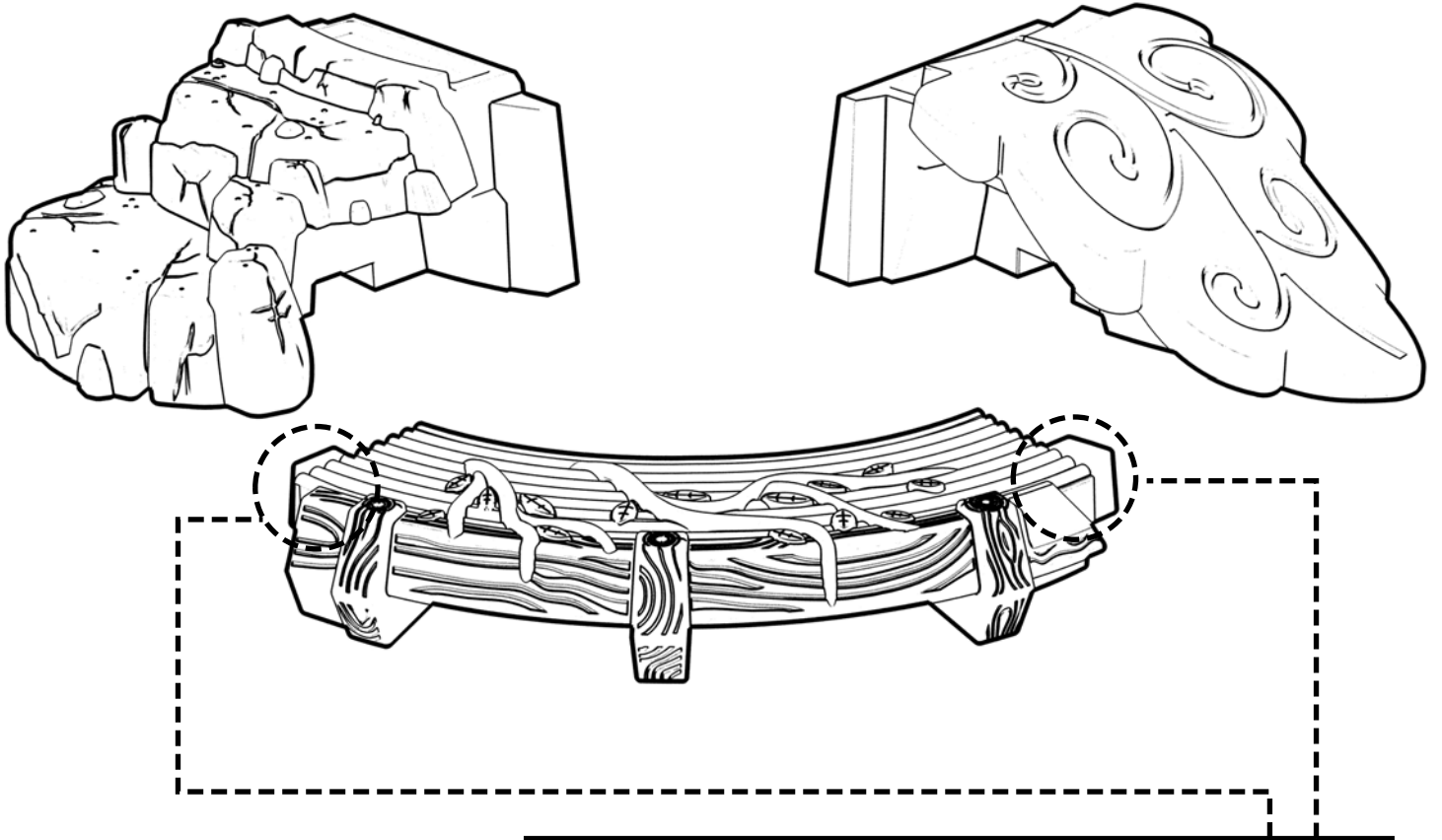

**Hardware Needed:**

**B** x2

**G** x2

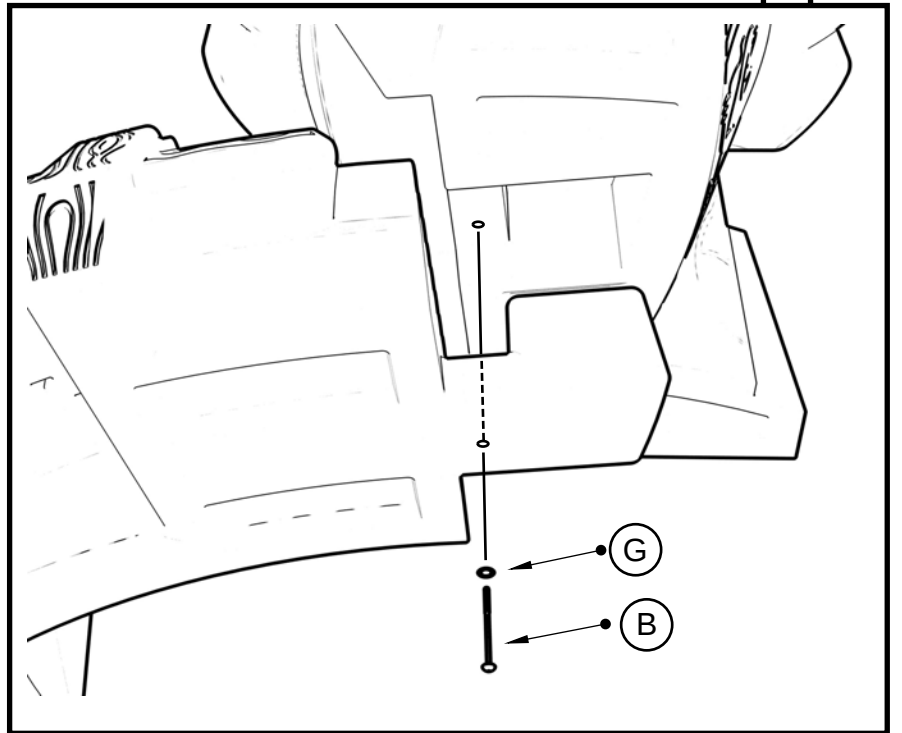

2

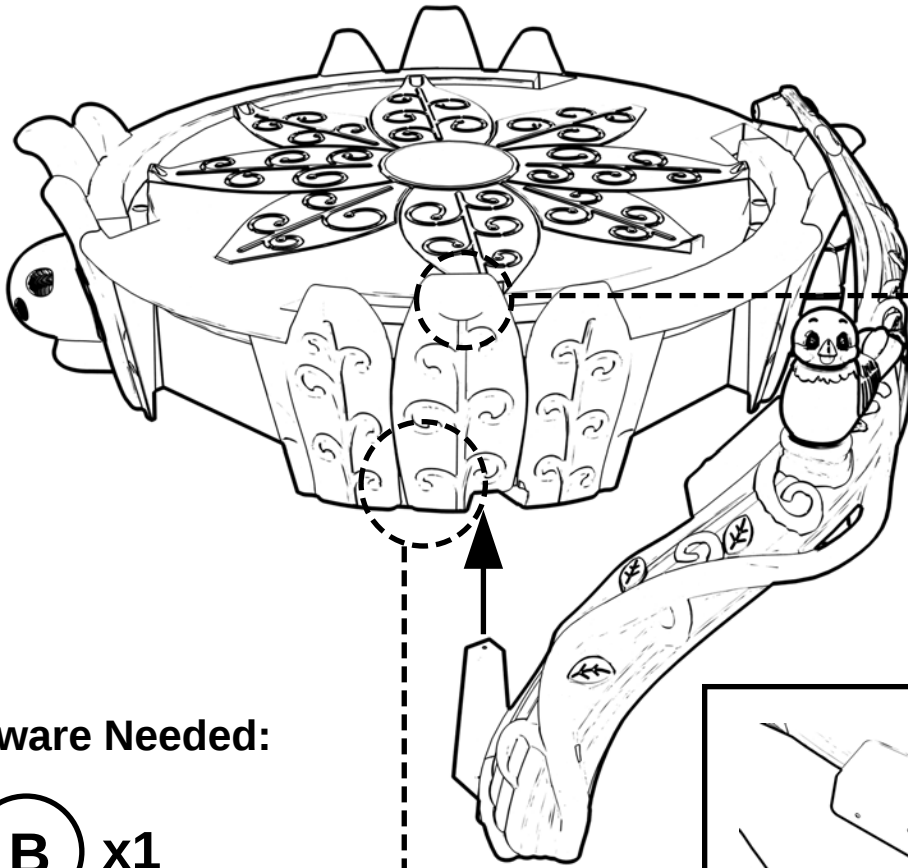

Hardware Needed:

(B) x1

(D) x1

(G) x2

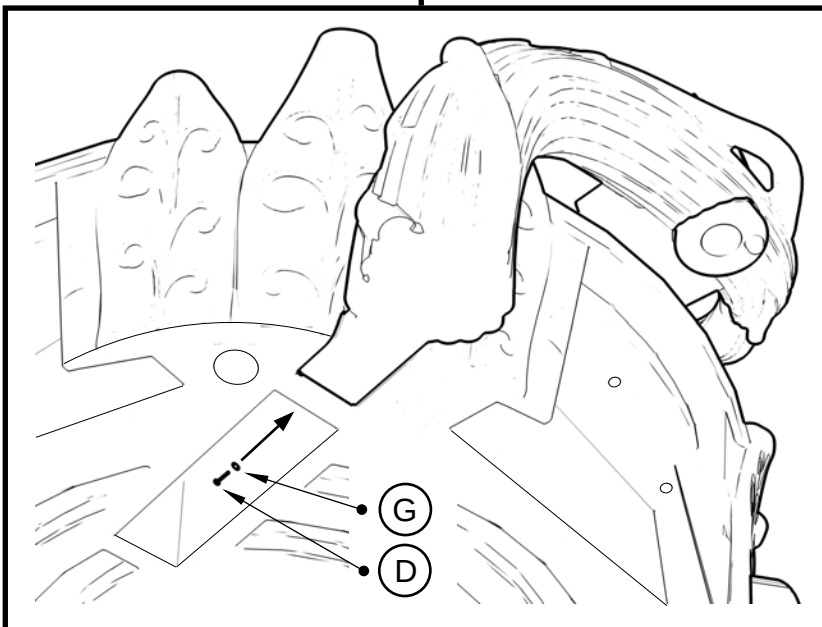
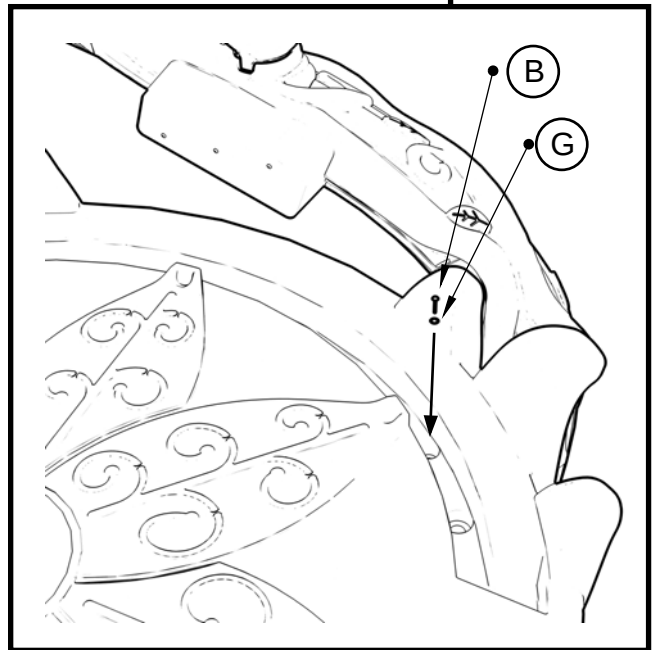



3a

Hardware Needed:

(B) x4

(G) x4

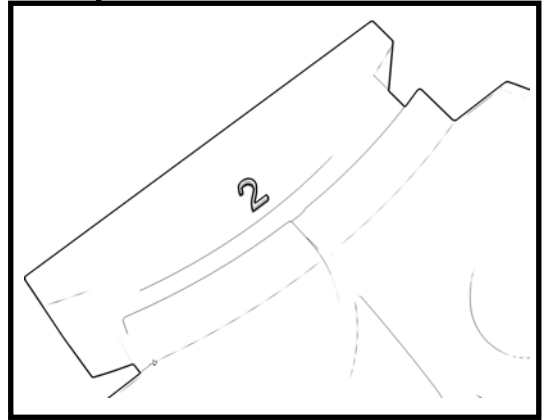
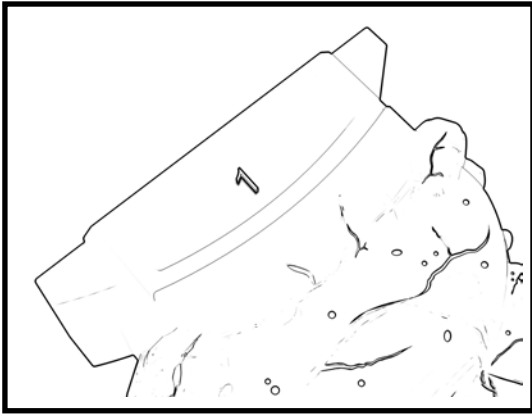
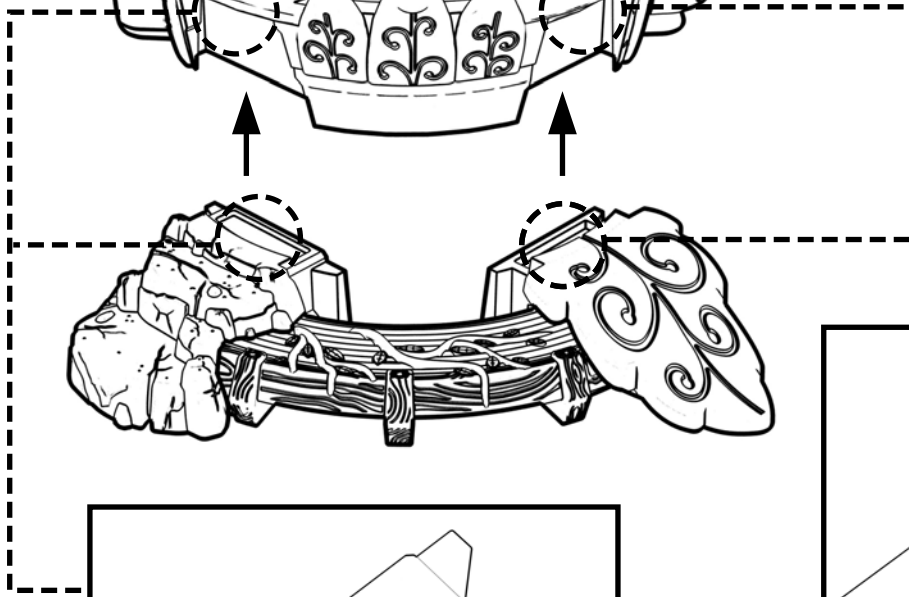

3b

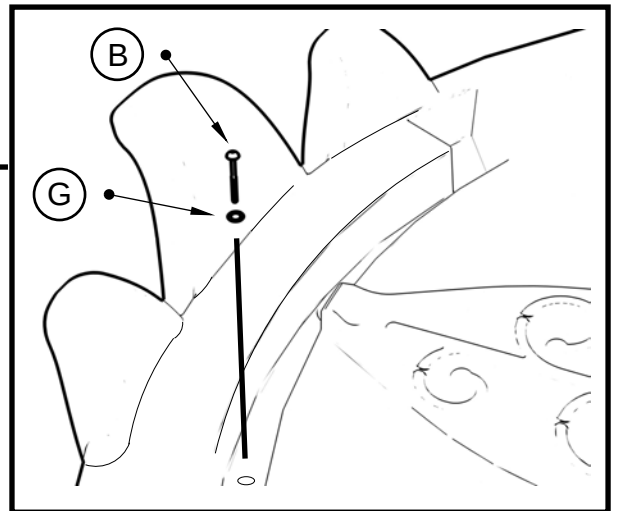
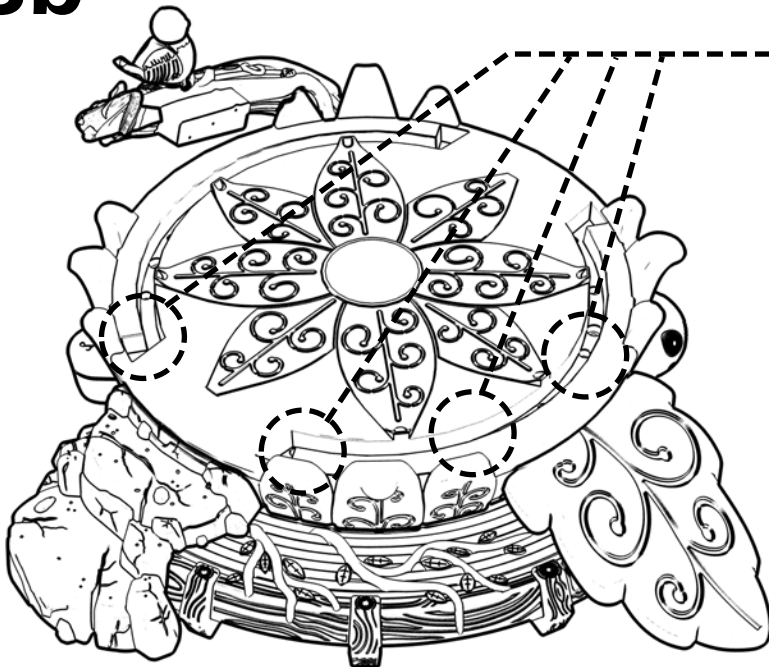

# 4a

Hardware Needed:

**(B)** x4

**(G)** x4

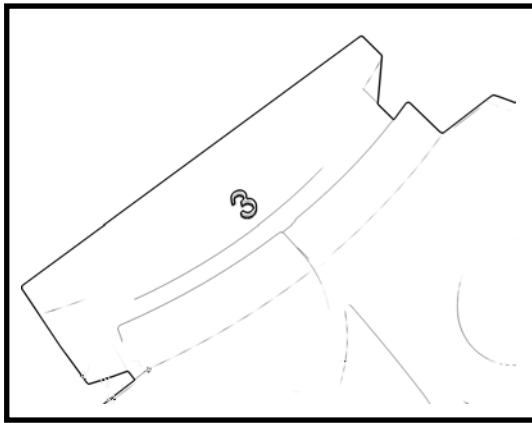
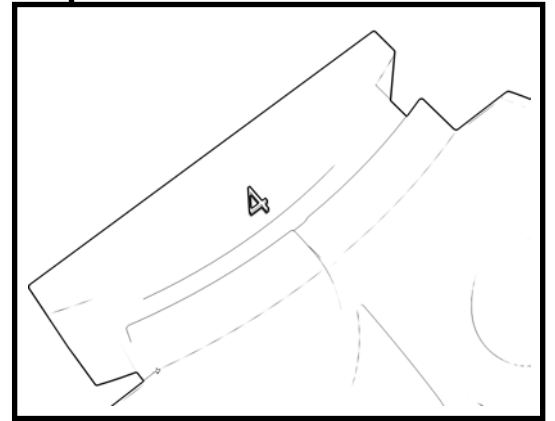
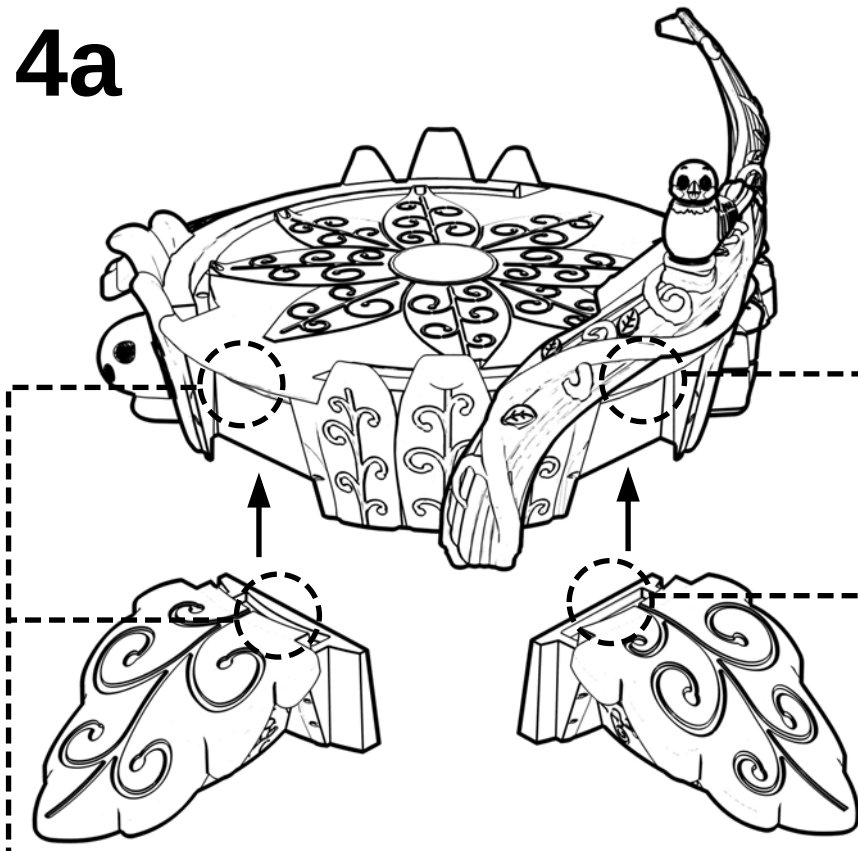

# 4b

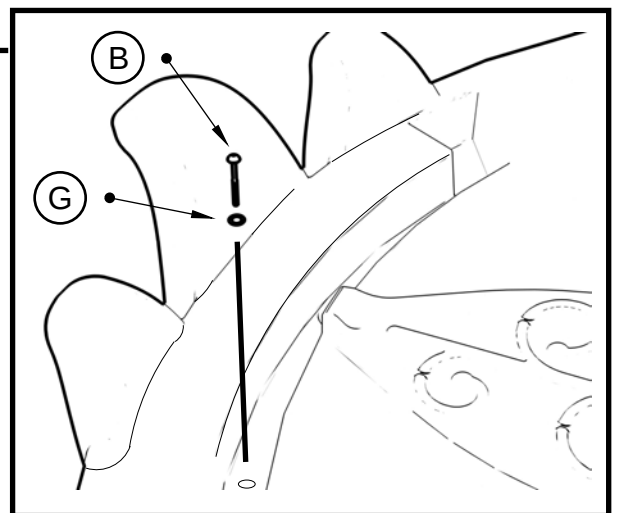
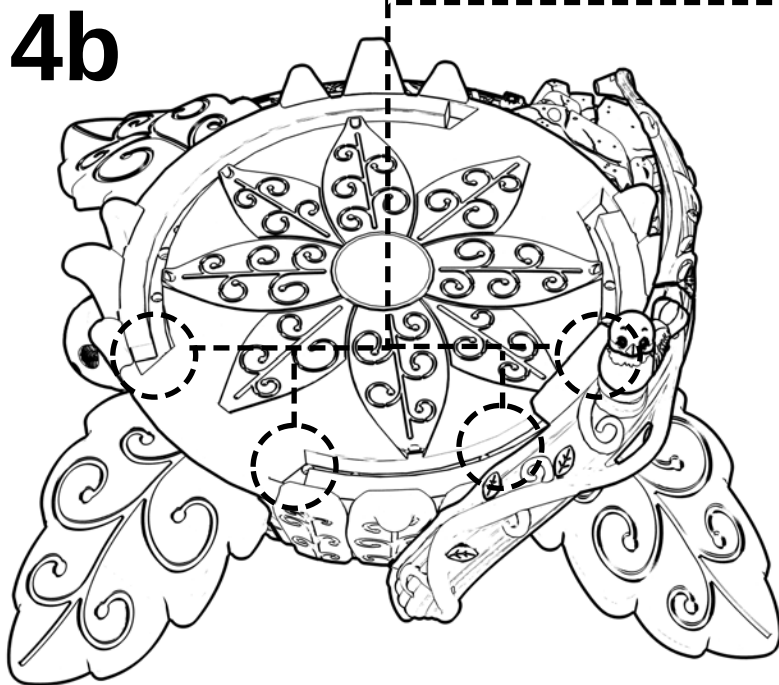

# 5 Optional Mounting Methods

Mount Packages Sold Separately

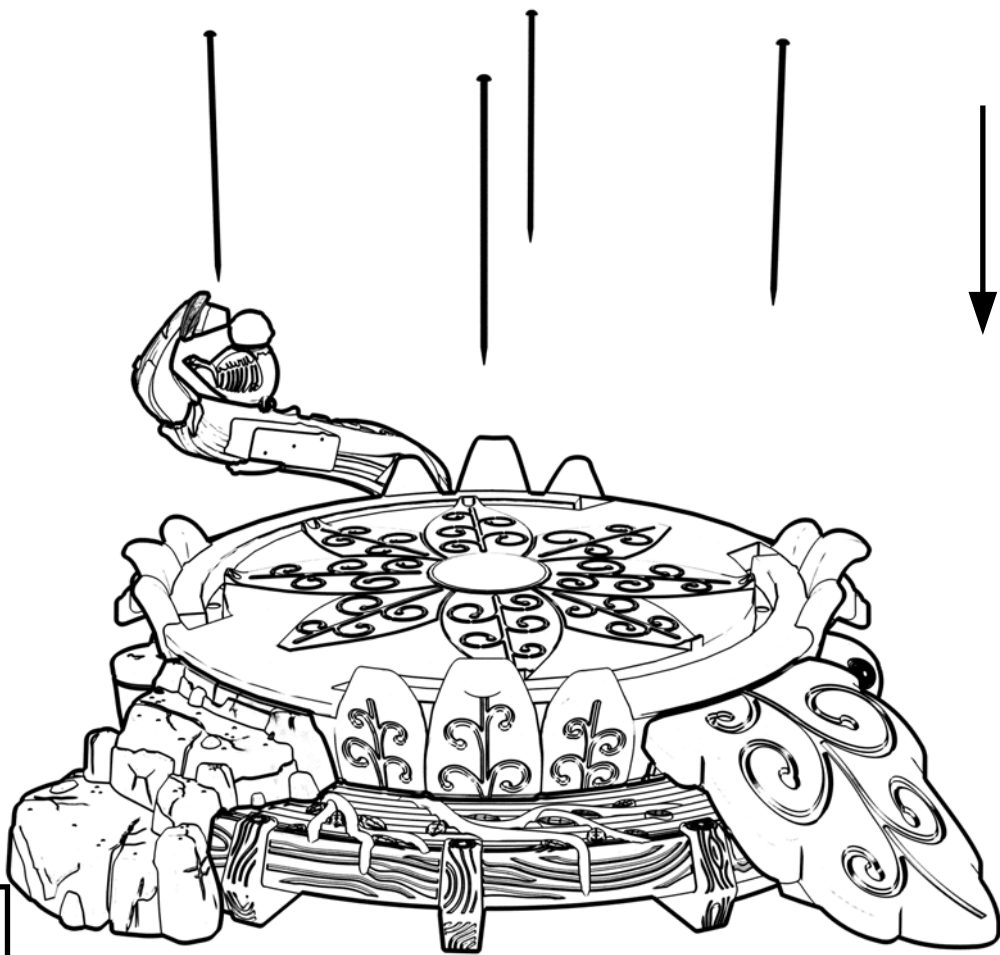

In-Ground Mounting Method

OR

Surface Mount Mounting Method

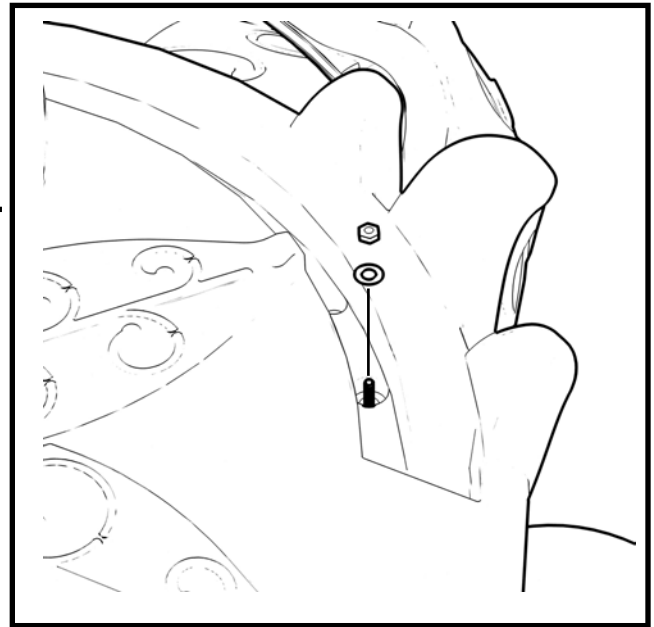
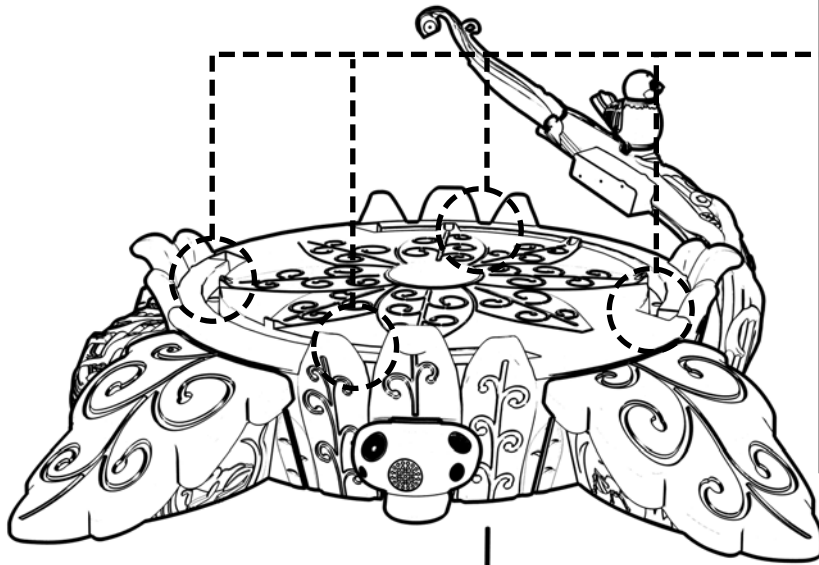

Hardware packaged with the mounting brackets

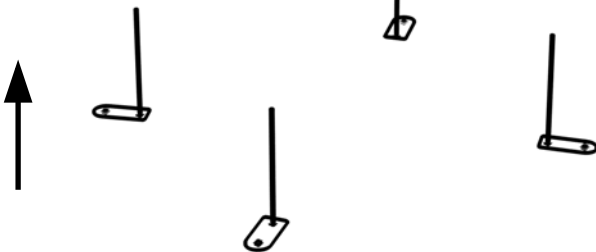

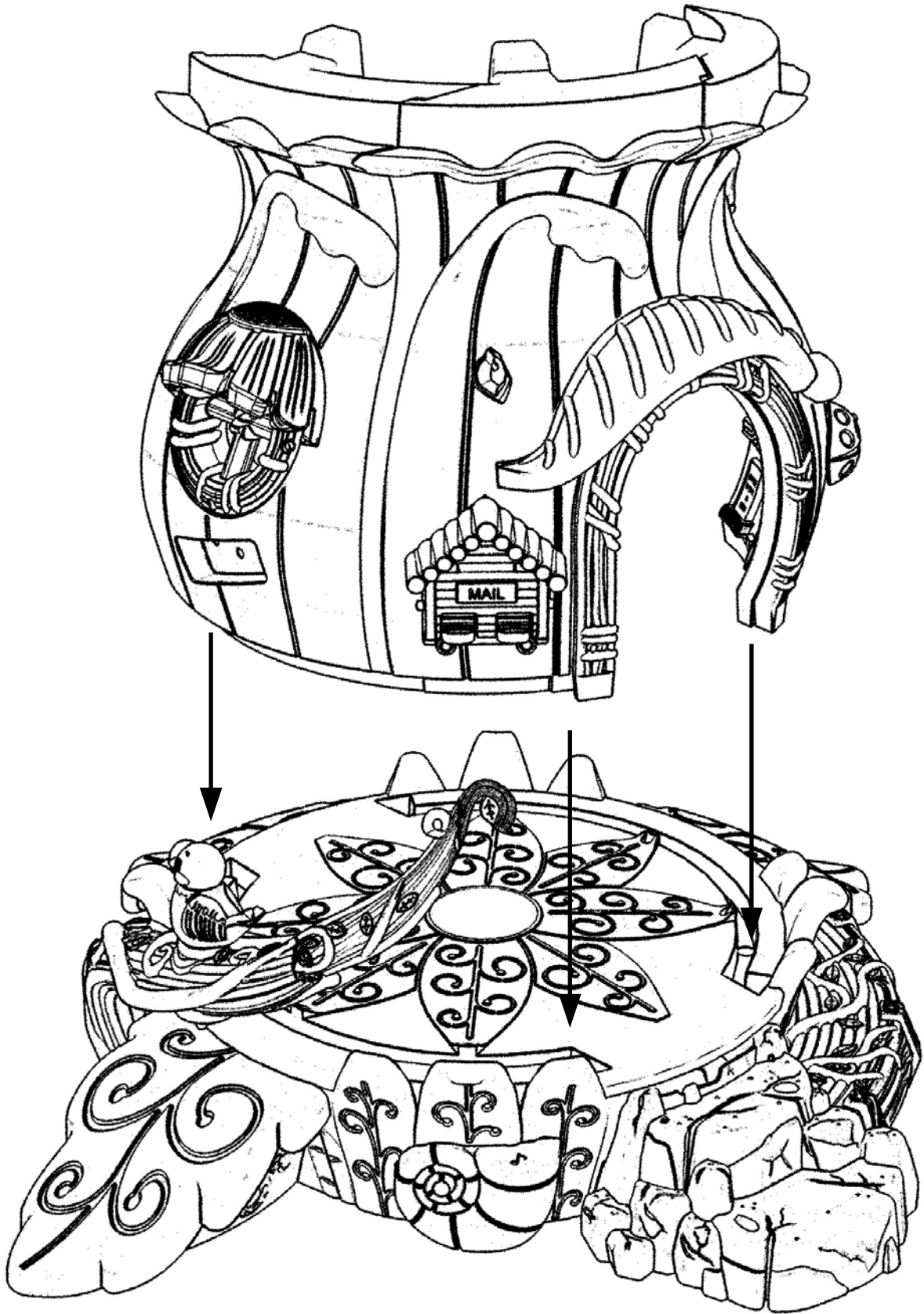

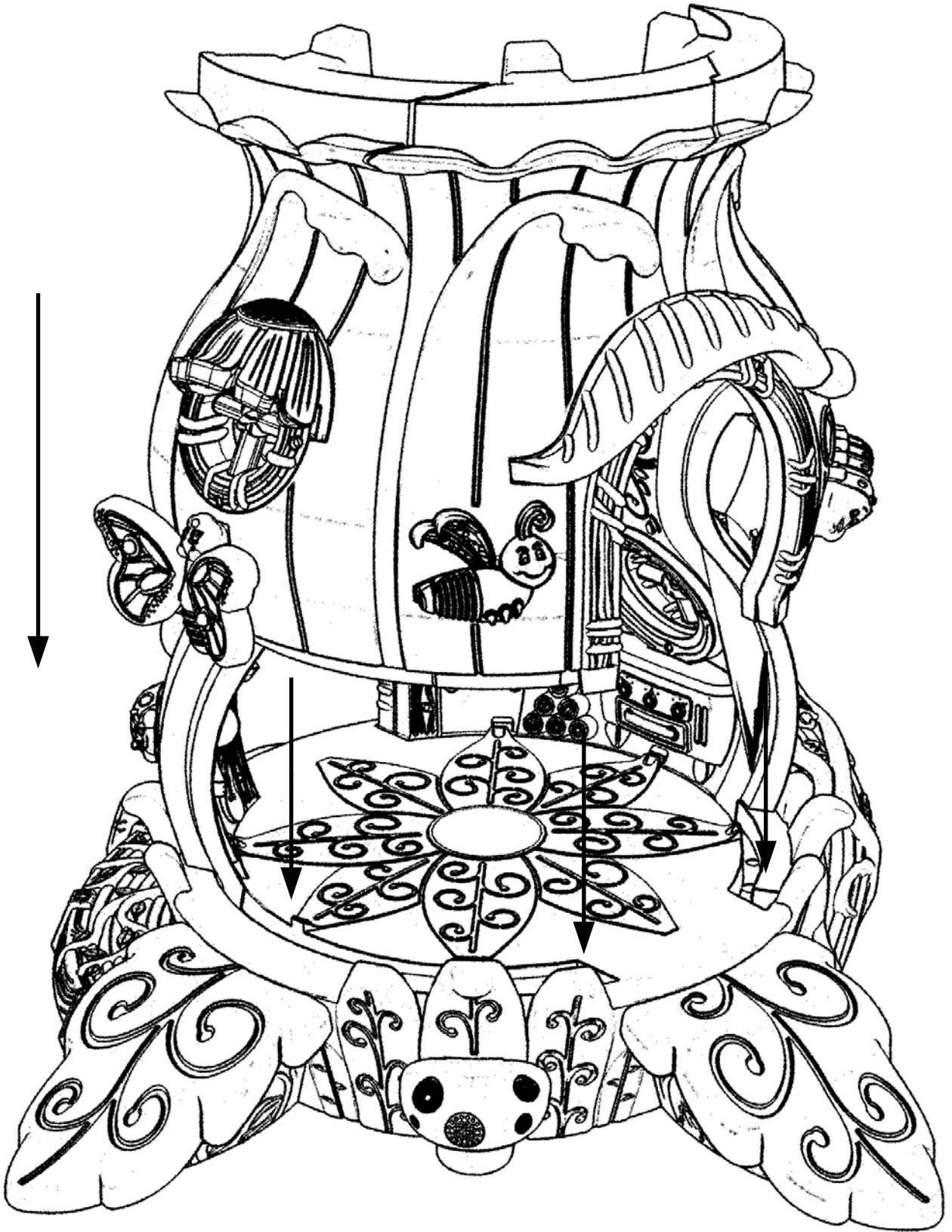

8

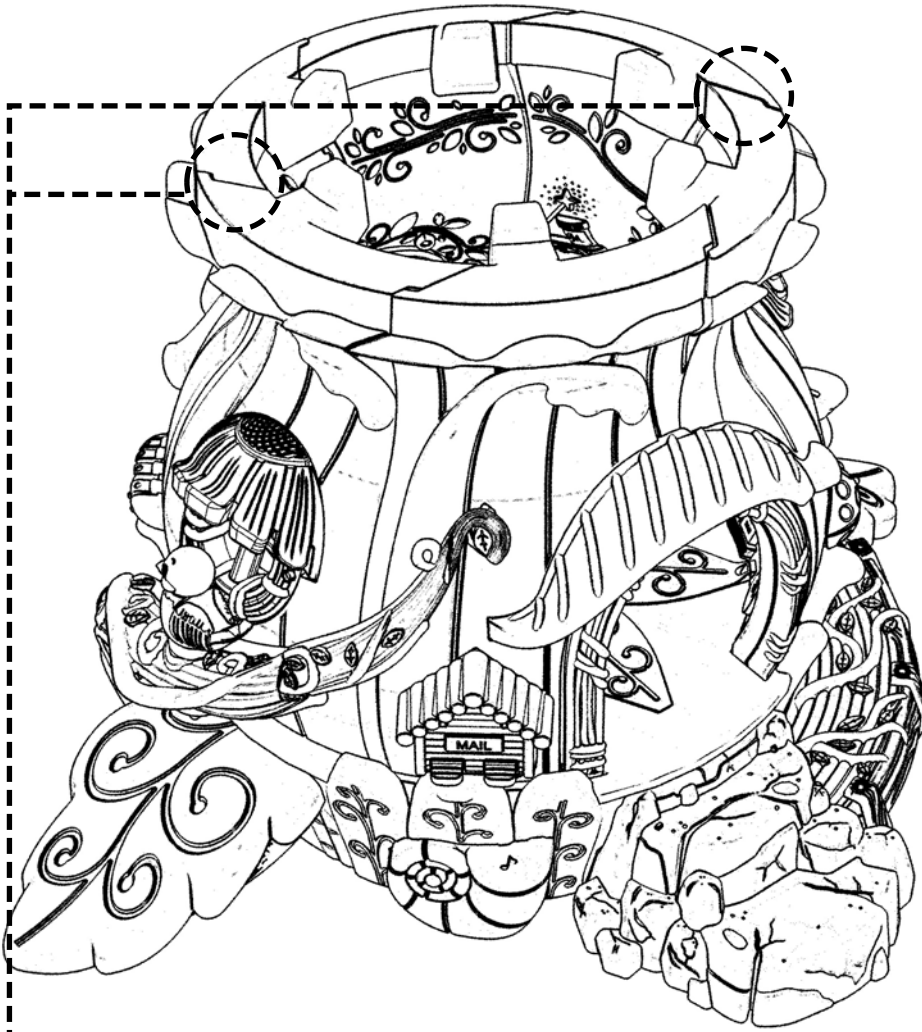

Hardware Needed:

(E) x2

(G) x4

(H) x2

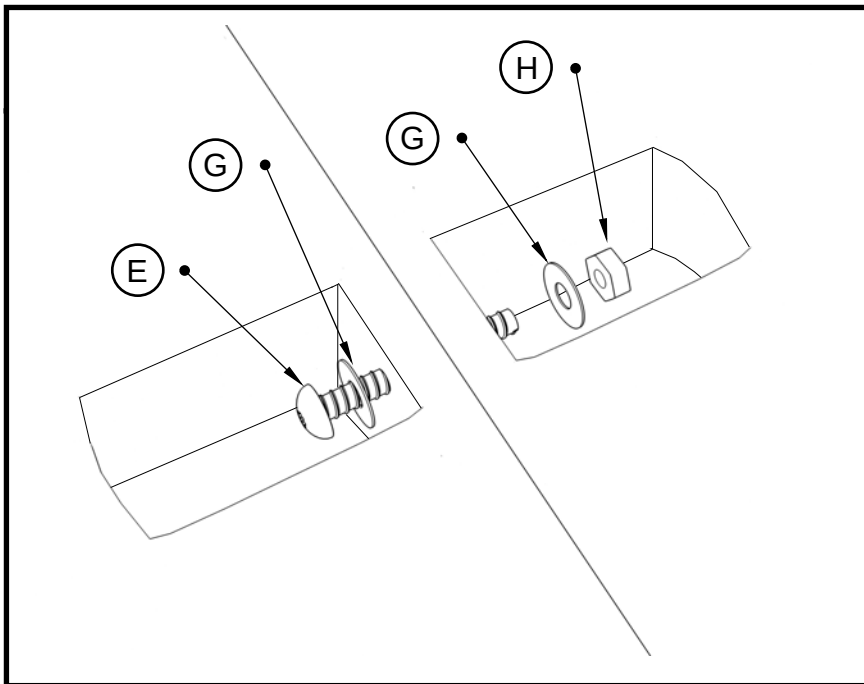

9

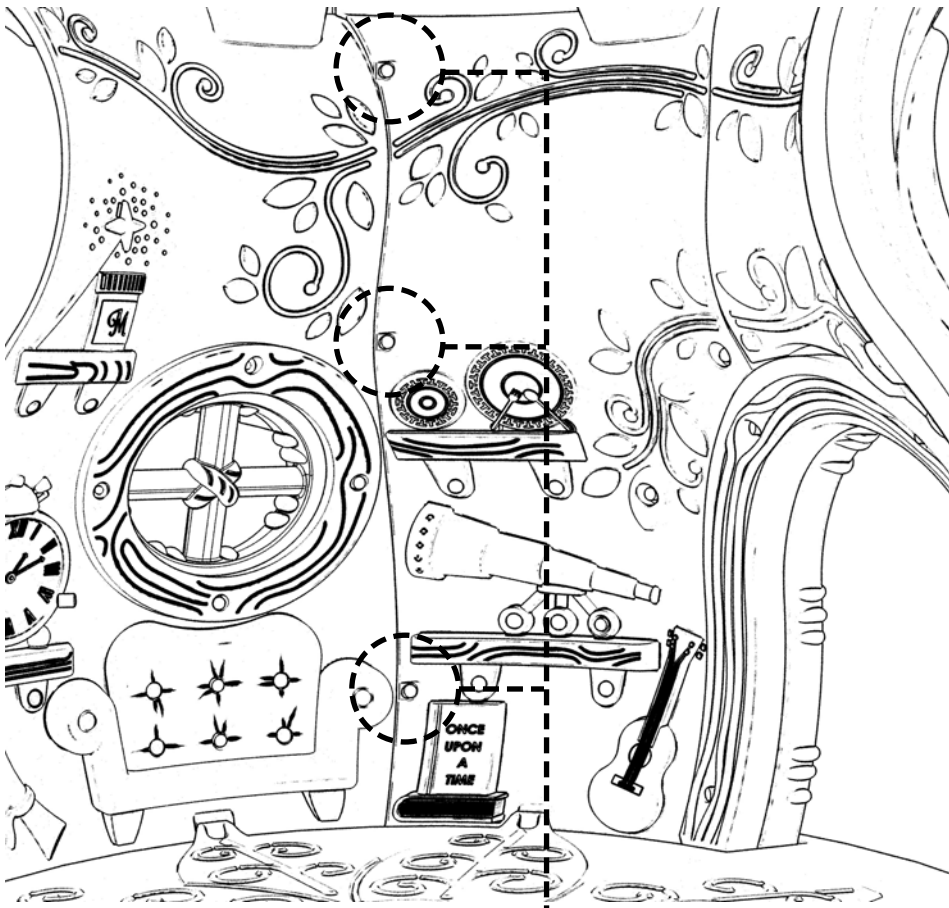

Hardware Needed:

**B** x6

**G** x6

**J** x6

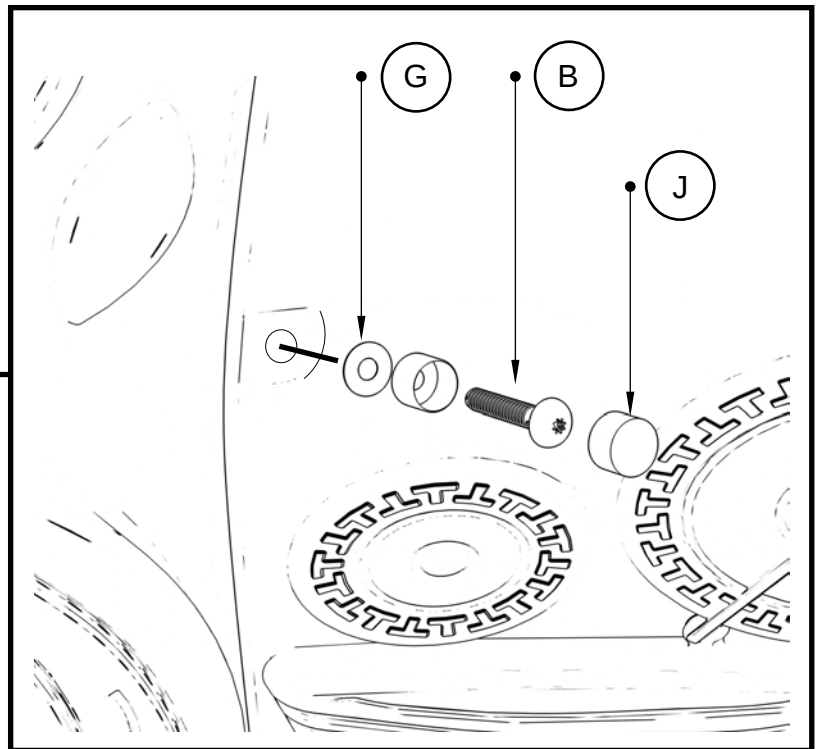

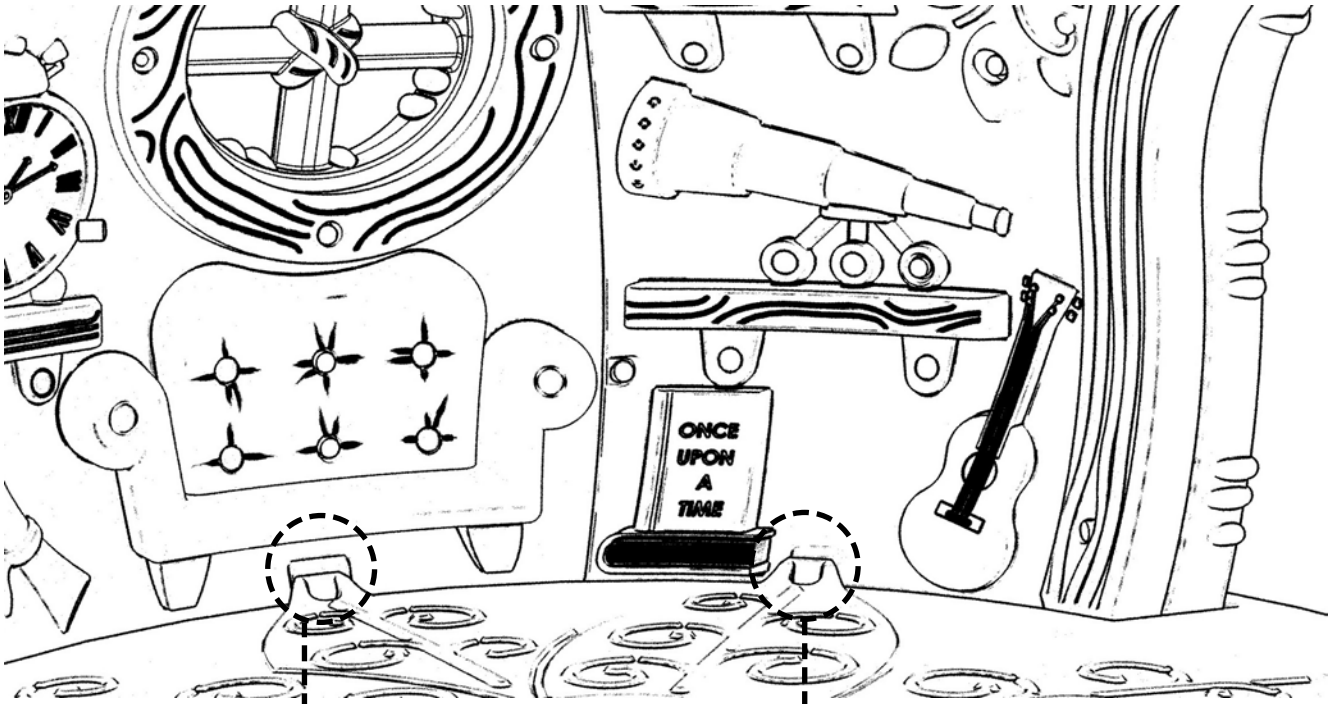

## Hardware Needed:

**(C)** x6

**(G)** x6

**(L)** x6

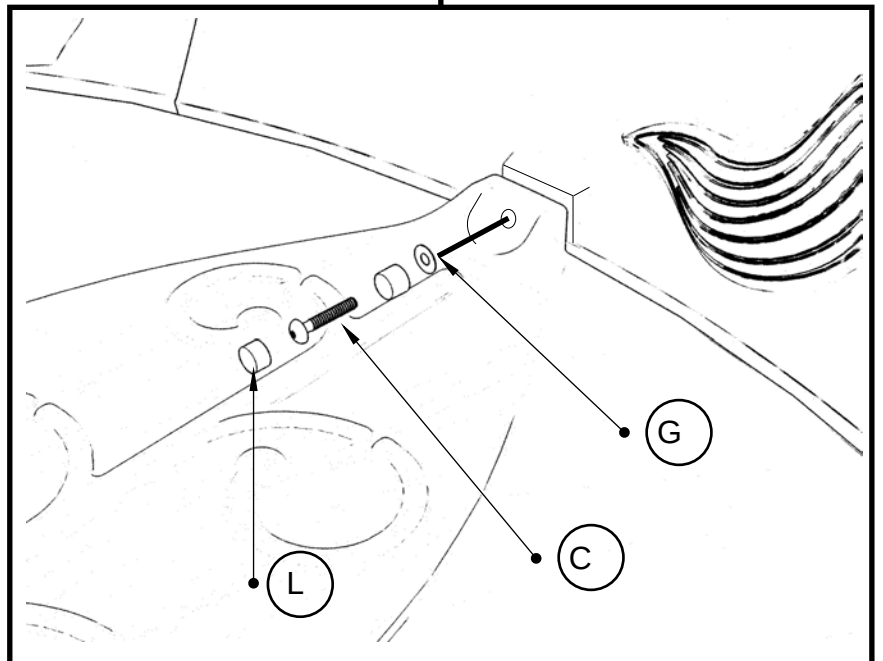



# 11

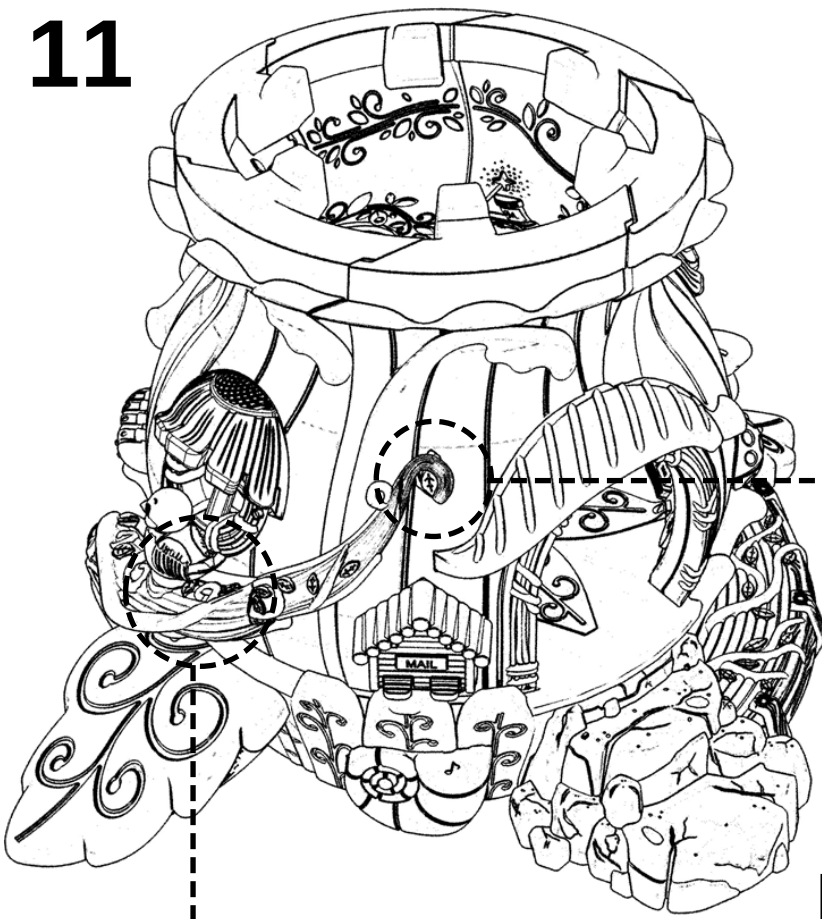

Hardware Needed:

(C) x1

(F) x3

(G) x4

(J) x4

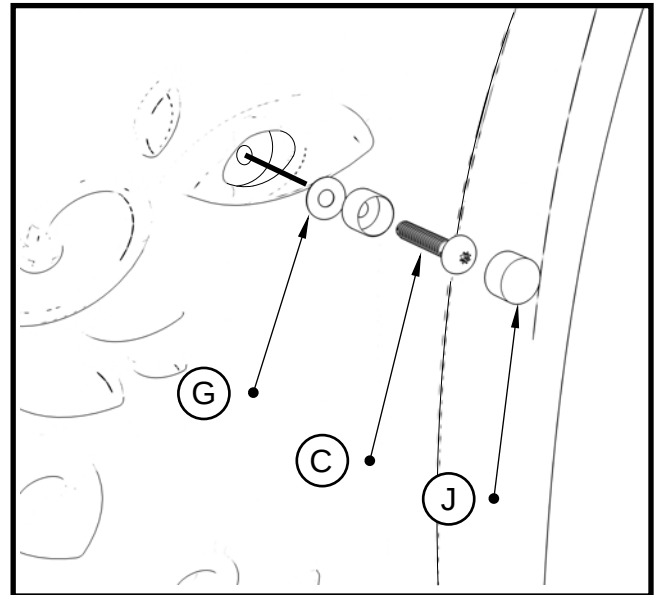
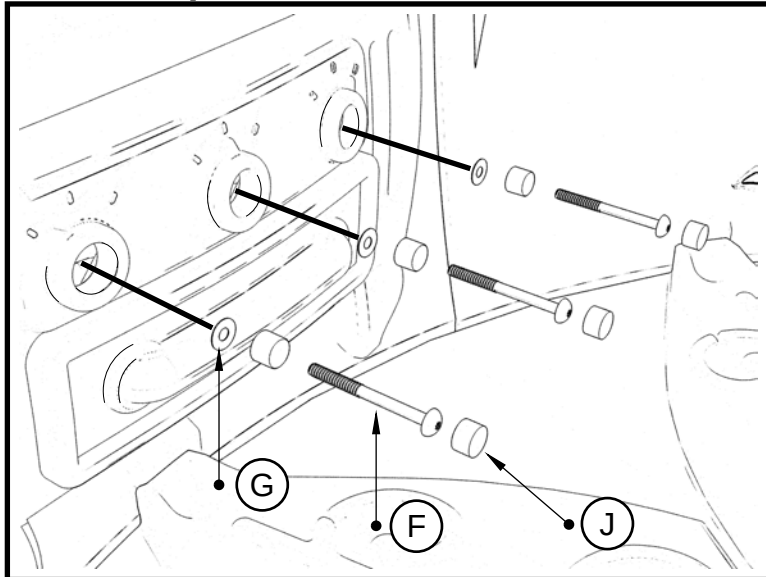

## Hardware Needed:

**D** x6

**G** x8

**I** x2

**K** x6

**L** x2

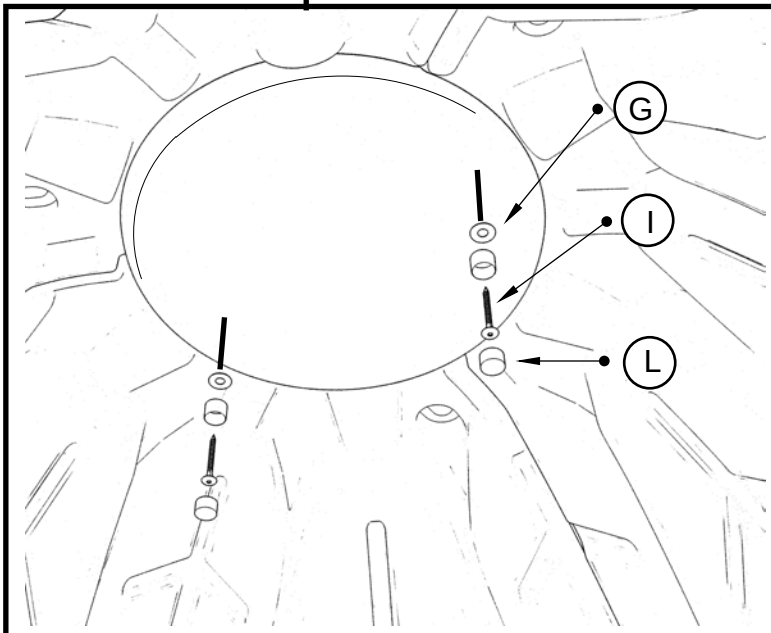
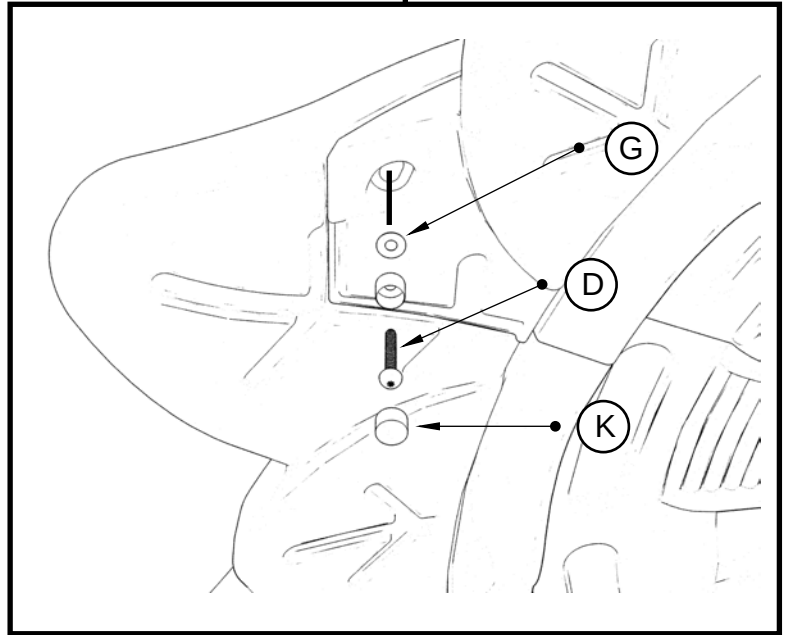
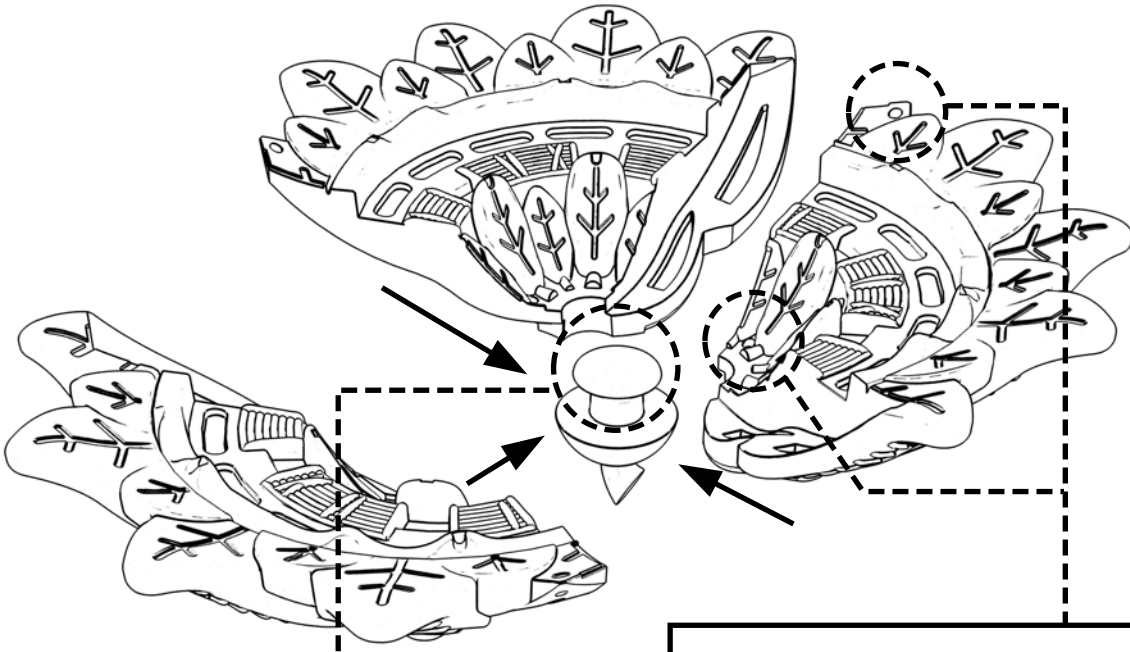

# 13

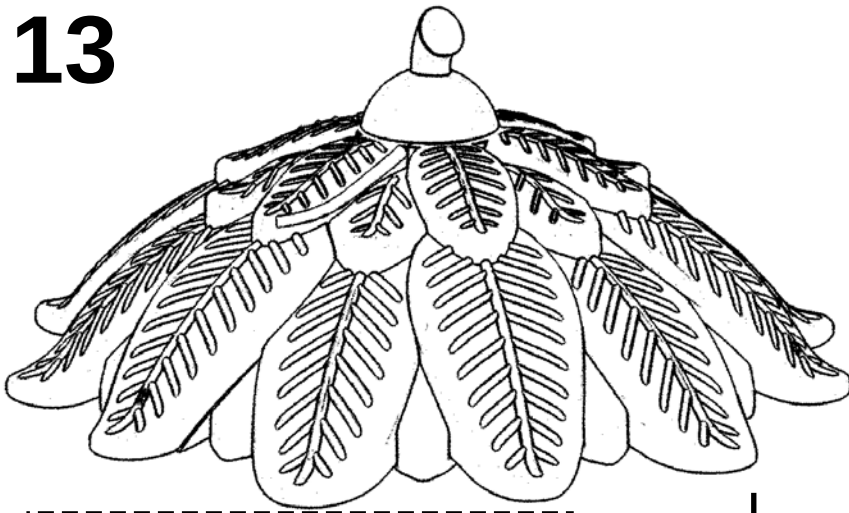

Hardware Needed:

ⓐ x6

ⓐ x6

ⓐ x6

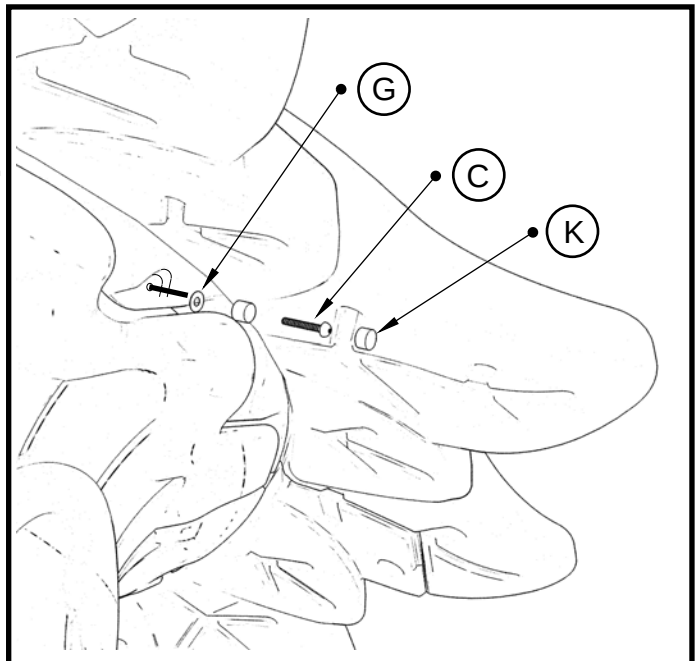
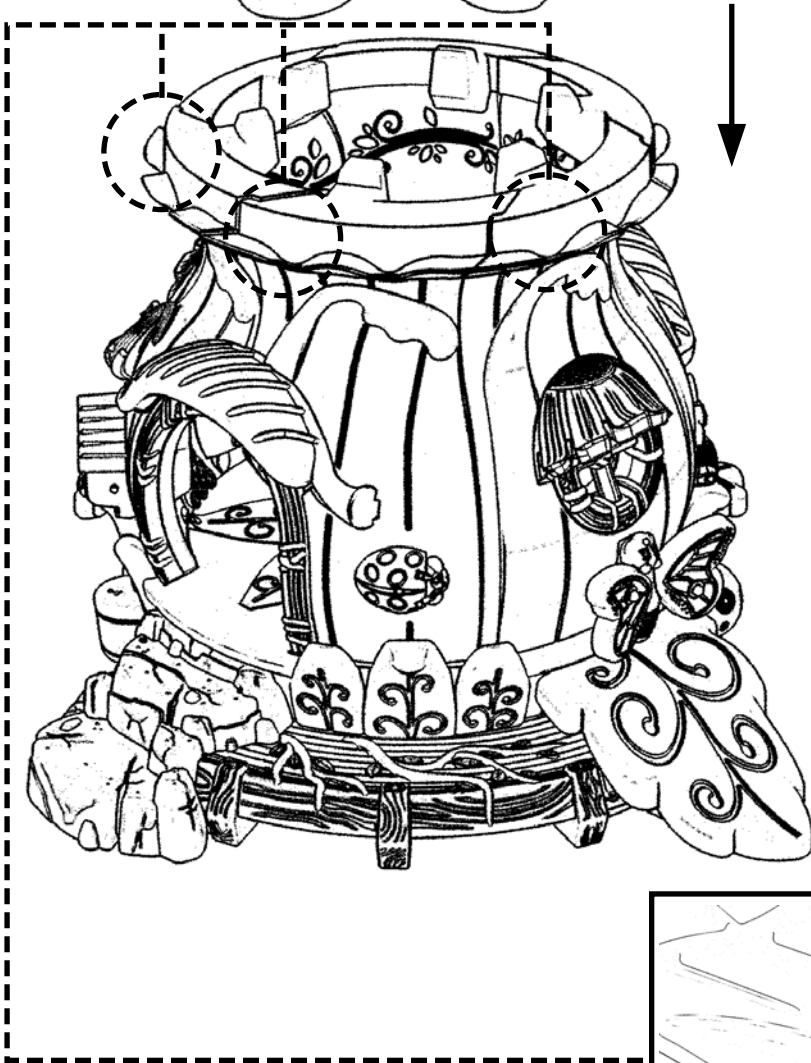

# Get the Most Out of Your Happy Hollow!

Unlock all of the resources you need related to Happy Hollow. Simply scan the QR code below or visit our website at:

[PlaygroundEquipment.com/happy-hollow-setup/](https://PlaygroundEquipment.com/happy-hollow-setup/)

## Get Free Access to:



Assembly Instructions and  
Manuals



Fun and Helpful Videos and  
Tools



Educational Guide and  
Extra Resources



[PlaygroundEquipment.com/happy-hollow-setup/](https://PlaygroundEquipment.com/happy-hollow-setup/)